

ROOFING *Accessories*



2019 Apollo Beach Plant
PRODUCT CATALOG

www.acm-metals.com

2019 Apollo Beach Plant
**ROOFING ACCESSORIES
CATALOG**

Table of Contents

Angle Flashing	2	Stucco Stop	9
Standard	2	Pre-Bent Step Flashing	10
No Kick	2	Rain Diverter	11
Base Flashing	2	Reglet Flashing	11
Drip Edge	3-7	Counter Flashing	11
Professional (Closed Face)	3-4	Philly Flashing	11
Standard (Closed Face)	4	J-Flashing	11
Roof Edge 90° with Kick	5	Roll Valley	11-12
Professional (Open Face)	5	W-Valley	12
Professional (Open Face with Back)	6	Roof to Wall Flashing	13
F-8 Large (Open Face)	6	Sidewall Flashing	13
Builders Alum. for Roof with 1/4" Overhang ..	6	Flat Sheet	13
Commercial for Roof with 1/4" Overhang ...	7	Flat Shingle	13
Premium Alum. for Roof with 1/4" Overhang ..	7	Tile & Patio Accessories	14
Rake Edge 90°	8	Tile Ridge Cap Riser	14
Gable FHA Trim	8	Kick Plate Channel (Roll Form)	14
Gravel Guard	8	Finish Trim	14
Gravel Stop	8		
Gutter Apron 25°	9		

PROUDLY FINISHED WITH
SHERWIN-WILLIAMS
Coil Coatings

We reserve the right to change the content of product offerings at any time. Please consult the online catalog at www.acm-metals.com for the most update product offering.

Contact Information:

CUSTOMER SERVICE: Ph 800-749-4067 • Fax 608-364-0598
www.acm-metals.com



Angle Flashing

Part #	Description	Colors	Nom. Gauge/ Thickness	Piece Length	Pieces/ Box	Boxes/ Pallet	Pieces/ Pallet
Standard							
GAF25410ML	Galvanized 2-1/2 x 4 (C6) Ang. Flash.	Mill	26 ga	10'	10	35	350
GAF3310 - -	Galvanized 3 x 3 (C6) Ang. Flash.	BK, RB, WH	26 ga	10'	10	35	350
GAF3310ML	Galvanized 3 x 3 (C6) Ang. Flash.	Mill	26 ga	10'	10	35	350
GAF4410 - -	Galvanized 4 x 4 (C7) Ang. Flash.	BK, RB, WH	26 ga	10'	10	35	350
GAF4410ML	Galvanized 4 x 4 (C7) Ang. Flash.	Mill	26 ga	10'	10	35	350

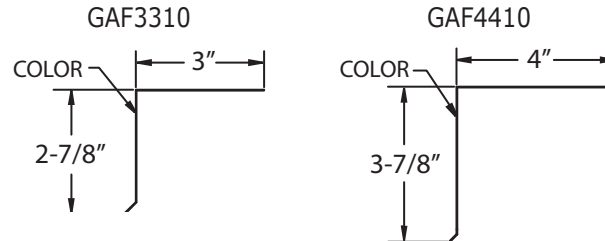
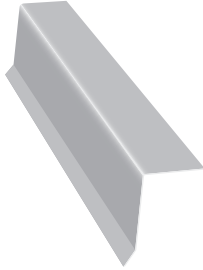

No Kick (Color Outside)

AAF2210WH	Aluminum 2 x 2 Angle Flashing	WH	0.019	10'	20	20	400
AAFH5510ML	Aluminum 5 x 5 Angle Flashing w/Hem	Mill	0.025	10'	20	20	400
GAFN4410ML	Galvanized 4 x 4 x 10 Angle Flashing	Mill	26 ga	10'	10	35	350
LJMD783ML	Galvalume 7/8 x 3 J-Mold Angle Flashing	Mill	26 ga	10'	25	20	500
LAF4510GL	Galvalume 4 x 5 Angle Flashing	Mill	26 ga	10'	20	20	400
LAF4610GL	Galvalume 4 x 6 Angle Flashing	Mill	26 ga	10'	20	20	400
LAF5510GL	Galvalume 5 x 5 Angle Flashing	Mill	26 ga	10'	20	20	400
LAF5710GL	Galvalume 5 x 7 Angle Flashing	Mill	26 ga	10'	20	20	400
LAFH666GL	Galvalume 6 x 6 Angle Flashing w/Hem	Mill	26 ga	10'	20	20	400

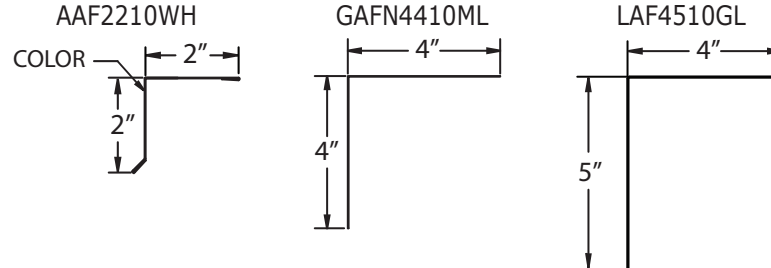

Base Flashing

Part #	Description	Colors	Nom. Gauge/ Thickness	Piece Length	Pieces/ Bundle	Pieces/ Pallet
GBF26933	Galvanized 3 x 3 Base Flashing 90°	Mill	26 ga	10'	25	1500
GBF26944	Galvanized 4 x 4 Base Flashing 90°	Mill	26 ga	10'	25	1500

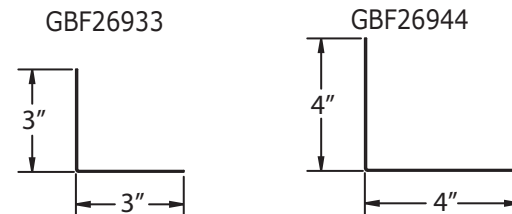
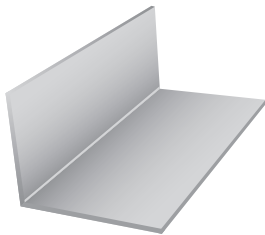

ALUMINUM Roofing Accessories Colors:

COLOR	CODE
WHITE	WH

STEEL Roofing Accessories Colors:

COLOR	CODE	COLOR	CODE	COLOR	CODE
BLACK	BK	ROYAL BROWN	RB	WHITE	WH

Drip Edge

Part #	Description	Colors	Nom. Gauge/ Thickness	Piece Length	Pieces/ Box	Boxes/ Pallet	Pieces/ Pallet
--------	-------------	--------	--------------------------	-----------------	----------------	------------------	-------------------

Professional - Closed Face

ADE10	Aluminum 1" Face with 2-7/8" Back (F5)	(Listed Below)	0.019	10'	50	24	1200
ADE15	Aluminum 1-1/2" Face with 3" Back (F5)	(Listed Below)	0.019	10'	50	24	1200
ADE15ML	Aluminum 1-1/2" Face with 3" Back (F5)	Mill	0.019	10'	50	24	1200
ADE185	Aluminum 1-3/4" Face with 2-5/8" Back	(Listed Below)	0.019	10'	50	24	1200
ADE185ML	Aluminum 1-3/4" Face with 2-5/8" Back	Mill	0.019	10'	50	24	1200
ADE2415WH	Aluminum 1-1/2" Face with 3" Back (F5)	WH	0.024	10'	25	24	600
ADE2420WH	Aluminum 2" Face with 3" Back (F5)	WH	0.024	10'	50	24	1200
GDE01515ML	Galvanized 1-1/2" x 1-1/2" Premium	Mill	30 ga	10'	25	100	2500
GDE15WH	Galvanized 1-1/2" Face with 3" Back	WH	30 ga	10'	25	24	600
GDE15ML	Galvanized 1-1/2" Face with 3" Back	Mill	30 ga	10'	25	24	600
GDE3022ML	Galvanized 2" x 2" Standard	Mill	30 ga	10'	25	60	1500
GDE822	Galvanized 2" x 2" Dual Safety Hem 90°	RB, WH	28 ga	10'	10	68	680
GDE20	Galvanized 2" Face (ODE) with 3" Back	RB, TB	28 ga	10'	25	24	600
GDE824	Galvanized 2" x 4" Dual Safety Hem 90°	BK, RB, WH	28 ga	10'	10	40	400
GDE2633ML	Galvanized 3" x 3" Drip Edge	Mill	26 ga	10'	25	60	1500
GDE2644ML	Galvanized 4" x 4" Drip Edge	Mill	26 ga	10'	25	60	1500
GDED266ML	Galvanized 6" Eave DL Formed	Mill	26 ga	10'	25	60	1500
GDED306AL	Galvanized 6" DL Drip Edge	AL	30 ga	10'	25	60	1500
GDEDL30	Galvanized DL Long Drip Edge	AL, BK, BR, WB, WH	30 ga	10'	25	60	1500
GDEDL30ML	Galvanized DL Long Drip Edge	Mill	30 ga	10'	25	60	1500
CDE15	Copper 1-1/2" Face with 3" Back	Copper	10 oz	10'	10	48	480

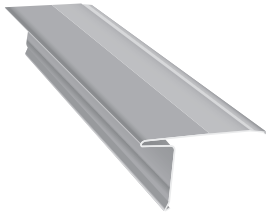

ADE10

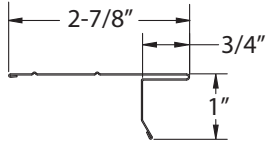

ADE15, GDE15, CDE15

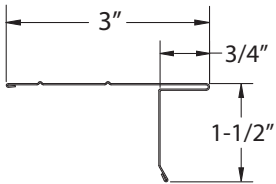

ADE185, ADE185ML

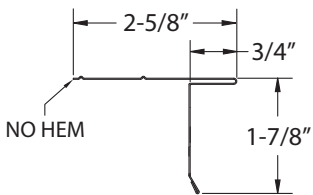

ADE2415

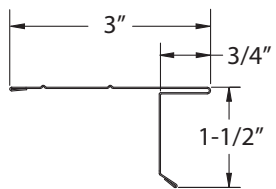

GDE3022ML

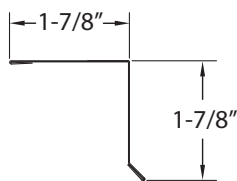

GDE822

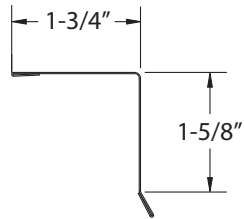

GDE20

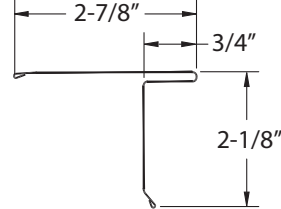

GDE824

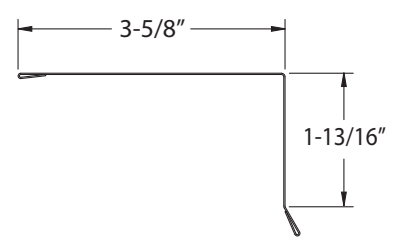

GDE2633ML

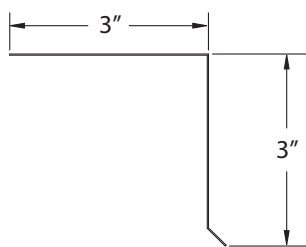

GDE2644ML

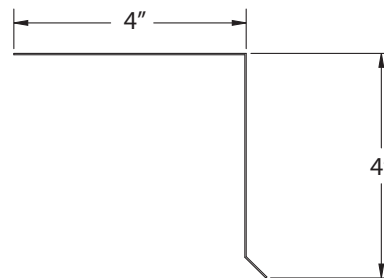

GDEDL30, GDEDL30ML

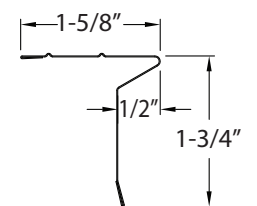

ALUMINUM Roofing Accessories Colors:

COLOR	CODE	COLOR	CODE	COLOR	CODE	COLOR	CODE	COLOR	CODE
ALMOND	AL	CAMEO	CA	MUSKET BROWN	MB	TERRA BRONZE	TB	WHITE	WH
BLACK	BK	DESERT SAND	DS	PEBBLESTONE CLAY	PC	VICTORIAN GRAY	VG	WICKER	WI
BRONZE	BZ	EVERGREEN	EG	ROYAL BROWN	RB				

STEEL Roofing Accessories Colors:

COLOR	CODE	COLOR	CODE	COLOR	CODE	COLOR	CODE
ALMOND	AL	BROWN	BR	TERRA BRONZE	TB	WEATHERED BRONZE	WB
BLACK	BK	ROYAL BROWN	RB			WHITE	WH

Drip Edge cont.

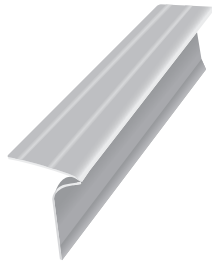

Part #	Description	Colors	Nom. Gauge/ Thickness	Piece Length	Pieces/ Box	Boxes/ Pallet	Pieces/ Pallet
Professional - Closed Face							
LDE15 - -	Galvalume 1-1/2" Face	BE, BK, BR, WH	26 ga	10'	25	20	500
LDE15ML	Galvalume 1-1/2" Face	Mill	26 ga	10'	25	20	500
LDE175BR	Galvalume 1-3/4" Face with 2-1/2" Back	BR	26 ga	10'	25	20	500
LDE20 - -	Galvalume 2" Face	BE, BK, BR, WH	26 ga	10'	25	20	500
LDE25 - -	Galvalume 2-1/2" Face	BE, BK, BR, CL, GY, WH, WI	26 ga	10'	25	20	500
LDE25ML	Galvalume 2-1/2" Face	Mill	26 ga	10'	25	20	500
LDE625 - -	Galvalume 2-1/2" Face 6/12	BE, BR, CL, WH	26 ga	10'	25	20	500
LDE625ML	Galvalume 2-1/2" Face 6/12	Mill	26 ga	10'	25	20	500
LDEEL25 - -	Galvalume 2-1/2" Face (Ext. Leg)	BK, BR, WH	26 ga	10'	25	20	500
TDE25WH	TPO 2-1/2" Face Drip Edge	WH	24 ga	10'	20/bundle		

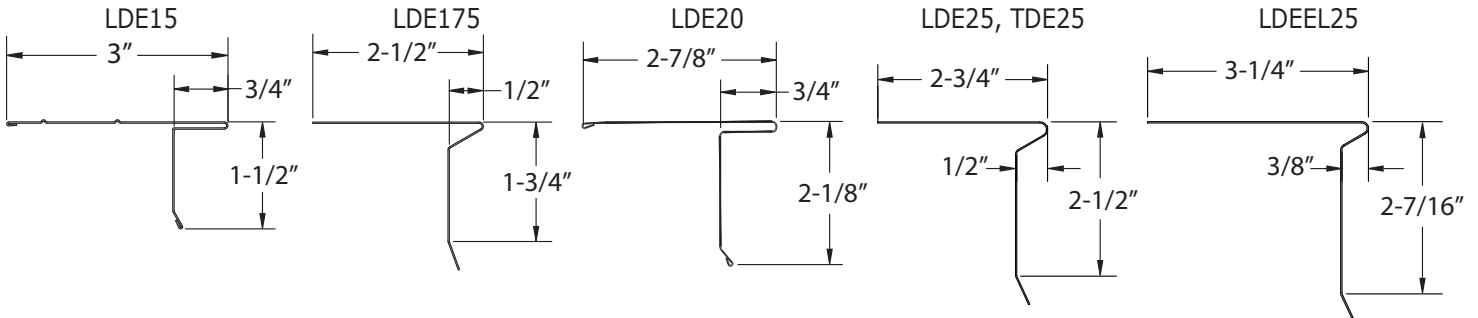

Standard - Closed Face

ESADE10 - -	Aluminum 1" Economy Face (F4-1/2)	RB, WH	0.015	10'	50	24	1200
SADE10 - -	Aluminum 1" Face (F4-1/2)	BK, WH	0.019	10'	50	24	1200
SADE125 - -	Aluminum 1-1/4" Face	BK, WH	0.019	10'	50	24	1200
SADE15 - -	Aluminum 1-1/2" Face (F5M)	BK, RB, TB, WH	0.019	10'	50	24	1200
SADE185 - -	Aluminum 1-3/4" Face (ODE)	BZ, WH, WI	0.019	10'	50	24	1200
SGDE10 - -	Galvanized 1" Face (F4-1/2)	BK, RB, TB, WH	28 ga	10'	25	24	600
SGDE10ML	Galvanized 1" Face (F4-1/2)	Mill	28 ga	10'	25	24	600
SGDE125 - -	Galvanized 1-1/4" Face	BK, RB, WH	28 ga	10'	25	24	600
SGDE125ML	Galvanized 1-1/4" Face	Mill	28 ga	10'	25	24	600
SGDE15 - -	Galvanized 1-1/2" Face (F5M)	BK, RB, TB, WH	28 ga	10'	25	24	600
SGDE15ML	Galvanized 1-1/2" Face (F5M)	Mill	28 ga	10'	25	24	600

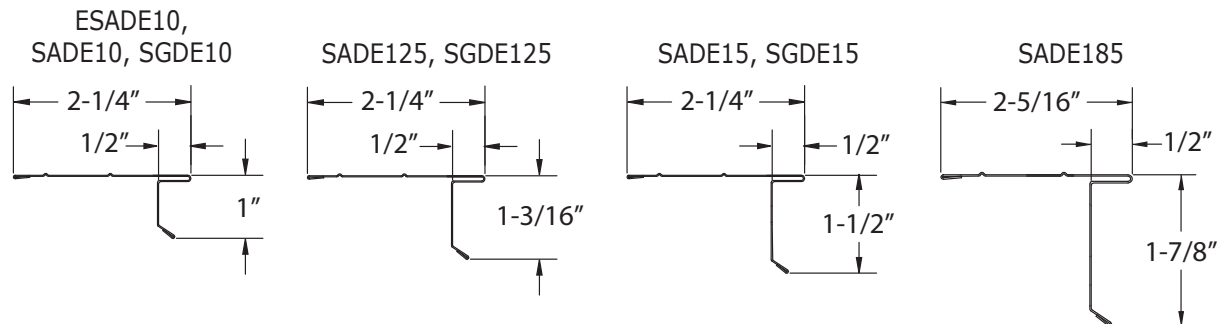

ALUMINUM Roofing Accessories Colors:

COLOR	CODE	COLOR	CODE	COLOR	CODE	COLOR	CODE	COLOR	CODE
BLACK	BK	ROYAL BROWN	RB	TERRA BRONZE	TB	WHITE	WH	WICKER	WI
BRONZE	BZ								

STEEL Roofing Accessories Colors:

COLOR	CODE	COLOR	CODE	COLOR	CODE	COLOR	CODE	COLOR	CODE
BEIGE	BE	BROWN	BR	GRAY	GY	TERRA BRONZE	TB	WICKER	WI
BLACK	BK	CLAY	CL	ROYAL BROWN	RB	WHITE	WH		

Drip Edge *cont.*

Part #	Description	Colors	Nom. Gauge/ Thickness	Piece Length	Pieces/ Box	Boxes/ Pallet	Pieces/ Pallet
Roof Edge - 90° with a Kick							
LRE22 - -	Galvalume 2 x 2 Roof Edge w/Kick 90°	BR, WH	26 ga	10'	25	20	500
LRE22ML	Galvalume 2 x 2 Roof Edge w/Kick 90°	Mill	26 ga	10'	25	20	500
LRE23WH	Galvalume 2 x 3 Roof Edge w/Kick 90°	WH	26 ga	10'	25	20	500
LRE23ML	Galvalume 2 x 3 Roof Edge w/Kick 90°	Mill	26 ga	10'	25	20	500
LRE33 - -	Galvalume 3 x 3 Roof Edge w/Kick 90°	BK, BR, WH	26 ga	10'	25	20	500
LRE33ML	Galvalume 3 x 3 Roof Edge w/Kick 90°	Mill	26 ga	10'	25	20	500
LRE2444 - -	Galvalume 4 x 4 Roof Edge w/Kick 90°	BR, WH	24 ga	10'	25	20	500
LRE2444ML	Galvalume 4 x 4 Roof Edge w/Kick 90°	Mill	24 ga	10'	25	20	500

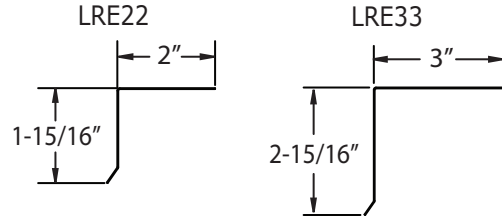

Professional - Open Face

ADE25 - -	Aluminum 2-1/2" Open Face	BR, WH	0.025	10'	25	20	500
ADE2545WH	Aluminum 4-1/2" Open Face	WH	0.025	10'	25	20	500
ADE2510WH	Aluminum 10" Open Face	WH	0.025	10'	25	20	500

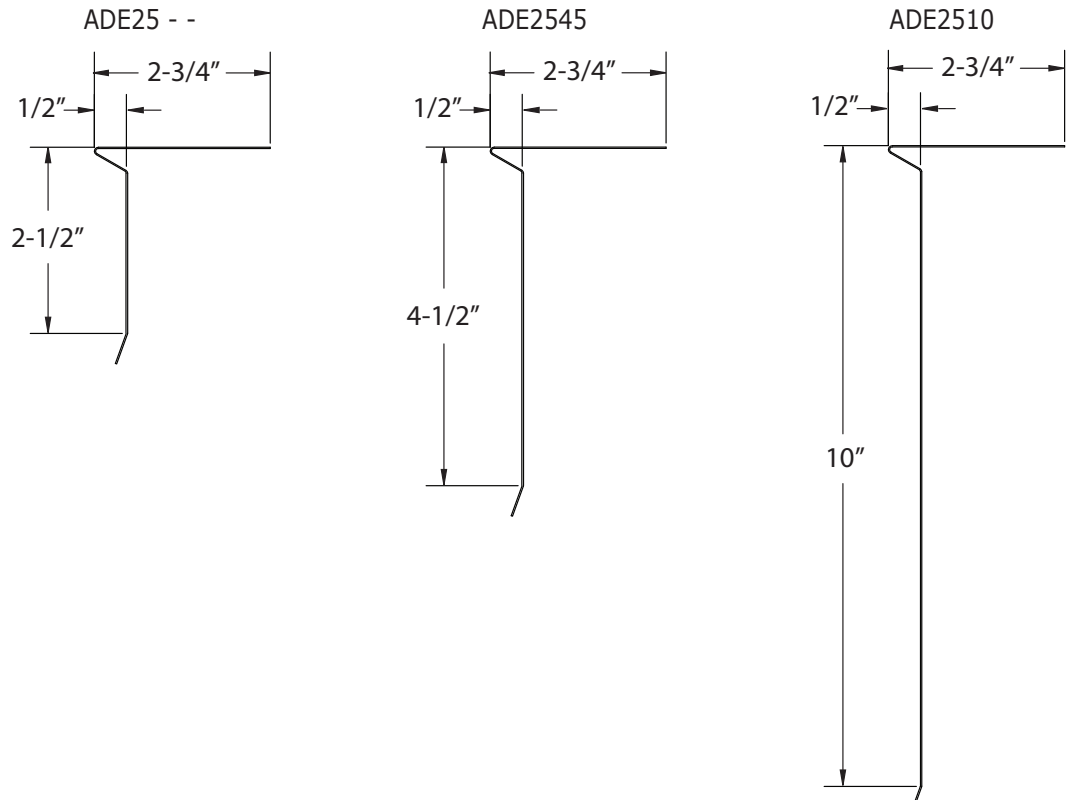

ALUMINUM Roofing Accessories Colors:

COLOR	CODE	COLOR	CODE
BROWN	BR	WHITE	WH

STEEL Roofing Accessories Colors:

COLOR	CODE	COLOR	CODE	COLOR	CODE
BLACK	BK	BROWN	BR	WHITE	WH

Drip Edge cont.

Part #	Description	Colors	Nom. Gauge/ Thickness	Piece Length	Pieces/ Box	Boxes/ Pallet	Pieces/ Pallet
Professional - Open Face with Back							
EADOF41WH	Alum. 1-1/2" Economy Open Face Drip Edge (F50)	WH	0.015	10'	50	24	1200
ADEOF10 - -	Alum. 1-1/2" Open Face w/3-3/4" Back (F5-1/20) BK, RB, TB, WH		0.019	10'	50	24	1200
ADEOF10ML	Alum. 1-1/2" Open Face w/3-3/4" Back (F5-1/20)	Mill	0.019	10'	50	24	1200
ADEOF415 - -	Alum. 1-1/2" Open Face w/2-3/8" Back (F50) BK, RB, WH		0.019	10'	50	24	1200
ADEOF415ML	Alum. 1-1/2" Open Face w/2-3/8" Back (F50)	Mill	0.019	10'	50	24	1200
GDEOF415 --	Galvanized 1-1/2" Open Face with 2-3/8" Back BK, RB, WH		28 ga	10'	20	24	480
GDEOF415ML	Galvanized 1-1/2" Open Face with 2-3/8" Back	Mill	28 ga	10'	20	24	480
GDEOF615 --	Galvanized 2" Open Face with 3-1/2" Back	RB, WH	26 ga	10'	20	24	480

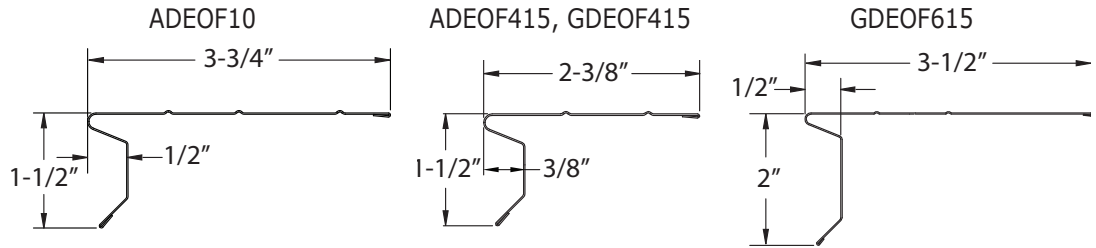
**F-8 Large - Open Face**

ADEF8 - -	Aluminum 1-1/2" Open Face w/5-3/4" Back (F8) BK, RB, WH		0.019	10'	25	24	600
GDEF8WH	Aluminum 1-1/2" Open Face w/5-3/4" Back (F8)	WH	28 ga	10'	15	24	360

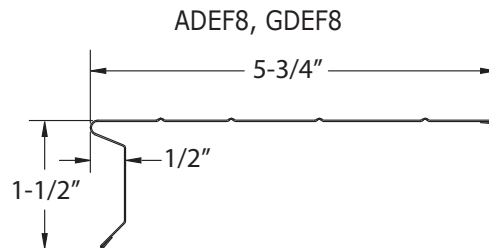
**Builders Aluminum for Roof with 1/4" Overhang**

★ADEWB17WH	Aluminum 1-3/4" Face Wood Grain w/Hem	WH	0.014	10'	50	24	1200
ADEB17WH	Aluminum 1-3/4" Face w/Hem	WH	0.014	10'	50	24	1200

★ "U" Status: Use up until gone.

ALUMINUM Roofing Accessories Colors:

COLOR	CODE	COLOR	CODE	COLOR	CODE	COLOR	CODE
BLACK	BK	ROYAL BROWN	RB	TERRA BRONZE	TB	WHITE	WH

STEEL Roofing Accessories Colors:

COLOR	CODE	COLOR	CODE	COLOR	CODE
BLACK	BK	ROYAL BROWN	RB	WHITE	WH

Drip Edge *cont.*

Part #	Description	Colors	Nom. Gauge/ Thickness	Piece Length	Pieces/ Boxes	Boxes/ Pallet	Pieces/ Pallet
Commercial Aluminum for Roof with 1/4" Overhang							
ADEC17 - -	Alum. 1-3/4" Face w/Hem	AI, TCG, CO, HY, TMB, WH, WI	0.019	10'	50	24	1200
ADEC20WH	Aluminum 2" Face w/Hem	WH	0.019	10'	50	24	1200
ADEC25 - -	Aluminum 2-1/2" Face w/Hem	HY, TMB, WH	0.019	10'	50	24	1200
ADEWC17 - -	Alum. 1-3/4" Face Wood Grain w/Hem	AL, AI, CA, TCG, CO, HY, TMB, WH	0.019	10'	50	24	1200
ADEWC20WH	Aluminum 2" Face Wood Grain w/Hem	WH	0.019	10'	50	24	1200
ADEWC25 - -	Alum. 2-1/2" Face Wood Grain w/Hem	AL, HY, TMB, WH	0.019	10'	50	24	1200

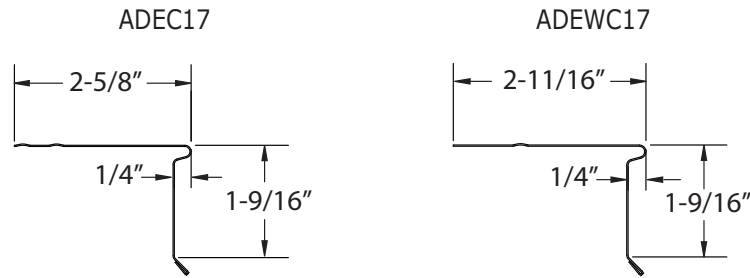

Commercial Aluminum Drip Edge Colors:

COLOR	CODE	COLOR	CODE	COLOR	CODE	COLOR	CODE	COLOR	CODE
ALMOND	AL	CAMEO	CA	COLONIAL GRAY	CO	TAMPA MUSKET BROWN	TMB	WICKER	WI
ANTIQUÉ IVORY	AI	TAMPA CHARCOAL GRAY	TCG	HICKORY BROWN	HY	WHITE	WH		

Premium Aluminum for Roof with 1/4" Overhang

ADED17WH	Alum. 1-3/4" Face w/Hem	WH	0.024	10'	50	24	1200
ADED20WH	Alum. 2" Face w/Hem	WH	0.024	10'	50	24	1200
ADED25 - -	Alum. 2-1/2" Face w/Hem	TSE, TSM, WH	0.024	10'	50	24	1200
ADEWD17 - -	Alum. 1-3/4" Face Wood Grain w/Hem	TMB, WH	0.024	10'	50	24	1200
ADEWD20 - -	Alum. 2" Face Wood Grain w/Hem	TMB, WH	0.024	10'	50	24	1200

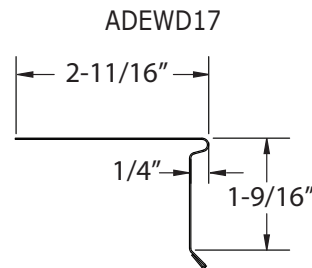

Premium Aluminum Roofing Accessories Colors:

COLOR	CODE	COLOR	CODE	COLOR	CODE	COLOR	CODE
TAMPA MUSKET BROWN	TMB	TAMPA STERLING GRAY	TSE	TAMPA SOFT MAPLE	TSM	WHITE	WH

Rake Edge 90°

Part #	Description	Colors	Nom. Gauge/ Thickness	Piece Length	Pieces/ Box	Boxes/ Pallet	Pieces/ Pallet
GRK15ML	Galv. 1-1/2" Face w/2-11/16" Back RE	Mill	28 ga	10'	25	27	675

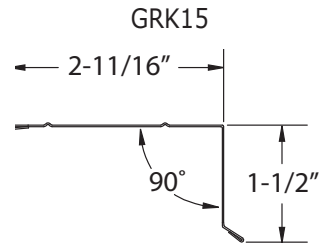
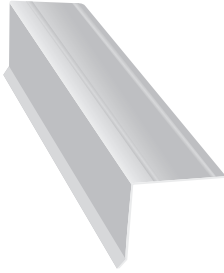
**Gable FHA Trim**

Part #	Description	Colors	Nom. Gauge/ Thickness	Piece Length	Pieces/ Bundle	Pieces/ Pallet
GGFF26ML	Galvanized Gable Flashing	Mill	26 ga	10'	25	1500

Gravel Guard

Part #	Description	Colors	Nom. Gauge/ Thickness	Piece Length	Pieces/ Bundle	Pieces/ Pallet
GGGM287ML	Galvanized 7" Gravel Guard	Mill	28 ga	10'	25	1500

Gravel Stop

Part #	Description	Colors	Nom. Gauge/ Thickness	Piece Length	Pieces/ Box	Pieces/ Bundle	Boxes/ Pallet	Pieces/ Pallet
AGS30WH	Alum. 3" Closed Face Gravel Stop	WH	0.019	10'		25		500
GGG30ML	Galv. 3" Face (H6F) Gravel Stop	Mill	24 ga	10'	10		35	350
GGG40ML	Galv. 4" Face (H6F) Gravel Stop	Mill	24 ga	10'	10		35	350
LGSO30ML	Glum. 3" Open Face Gravel Stop	Mill	26 ga	10'		25		

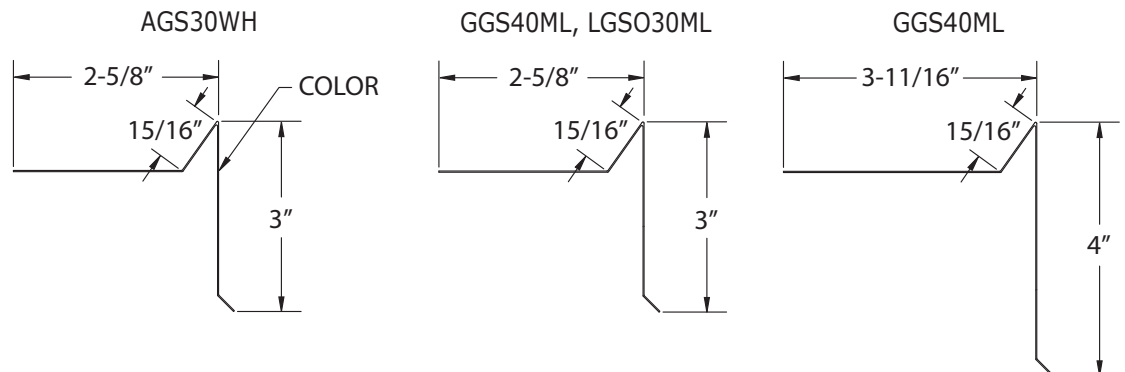
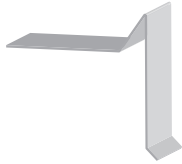

Gutter Apron 25°



Part #	Description	Color	Nom. Gauge/ Thickness	Piece Length	Pieces/ Box	Pieces/ Bundle	Boxes/ Pallet	Pieces/ Pallet
AGA15WH	Aluminum 1-1/2" Face	WH	0.019	10'	50		32	1600
AGA20 - -	Aluminum 2" Face	BK, RB, WH	0.019	10'	50		32	1600
GGA15WH	Galvanized 1-1/2" Face	WH	28 ga	10'		25	32	600
LGA20110ML	Galvalume 2" Face 110°	Mill	26 ga	10'		25	--	--
LGA23110ML	Glum. 2" Face w/3" Leg on Roof 110°	Mill	26 ga	10'		25	16	400
LGA30110WH	Galvalume 3" Face 110°	WH	26 ga	10'		25	20	500
LGA30110ML	Galvalume 3" Face 110°	Mill	26 ga	10'		25	20	500

AGA15, GGA15

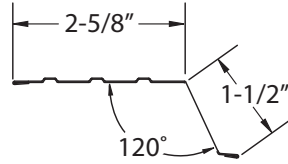

AGA20

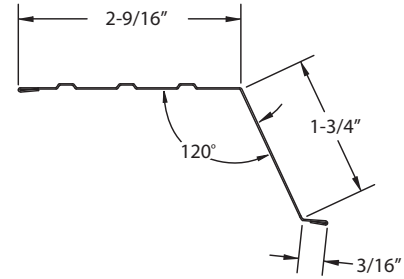

Stucco Stop

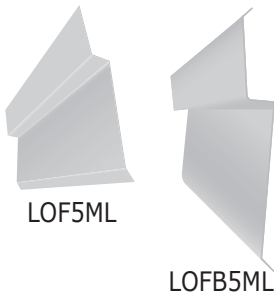

Part #	Description	Colors	Nom. Gauge/ Thickness	Piece Length	Pieces/ Bundle	Boxes/ Pallet	Pieces/ Pallet
LOF5ML	Galvalume 5" without Caulk	Mill	26 ga	10'	25	20	500
LOFB5ML	Galvalume 5" with Caulk Bead	Mill	26 ga	10'	25	20	500

LOFB5

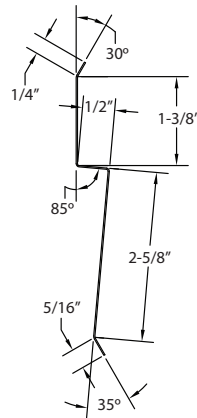

ALUMINUM Roofing Accessories Colors:

COLOR	CODE	COLOR	CODE	COLOR	CODE
BLACK	BK	ROYAL BROWN	RB	WHITE	WH

STEEL Roofing Accessories Colors:

COLOR	CODE	COLOR	CODE	COLOR	CODE
BLACK	BK	BROWN	BR	WHITE	WH

Pre-Bent Step Flashing



Part #	Description	Color	Nom. Gauge/ Thickness	Piece Length	Pieces/ Bundle
APSF237 - -	Aluminum 2 x 3 x 7 PB Step Flashing	BK, RB	0.011	7"	100
APSF237ML	Aluminum 2 x 3 x 7 PB Step Flashing	Mill	0.011	7"	100
APSF57 - -	Aluminum 2-1/2 x 2-1/2 x 7 PB Step Flash.	BK, RB	0.011	7"	100
APSF57ML	Aluminum 2-1/2 x 2-1/2 x 7 PB Step Flash.	Mill	0.011	7"	100
APSF347 - -	Aluminum 3 x 4 x 7 PB Step Flashing	BK, RB, TB	0.011	7"	100
APSF347ML	Aluminum 3 x 4 x 7 PB Step Flashing	Mill	0.011	7"	100
APSF557BK	Aluminum 5 x 5 x 7 PB Step Flashing	BK	0.011	7"	100
APSF558BK	Aluminum 5 x 5 x 8 PB Step Flashing	BK	0.011	8"	100
APSF5585 - -	Aluminum 5 x 5 x 8 PB Step Flashing	BK, RB	0.011	8"	50
APSF5585ML	Aluminum 5 x 5 x 8 PB Step Flashing	Mill	0.011	8"	50
APSF1788TB	Aluminum 8 x 8 PB Step Flashing	TB	0.019	8"	100
APSF2885BK	Aluminum 8 x 8 PB Step Flashing	BK	0.024	8"	50
APSF88 - -	Aluminum 8 x 8 PB Step Flashing	BK, RB, TB	0.011	8"	100
APSF88ML	Aluminum 8 x 8 PB Step Flashing	Mill	0.011	8"	100
GPSF347ML	Galvanized 3 x 4 x 7 PB Step Flashing	Mill	30 ga	7"	100
GPSF57ML	Galvanized 5 x 7 PB Step Flashing	Mill	28 ga	7"	100
GPSF88 - -	Galvanized 8 x 8 PB Step Flashing	BK, RB, TB	30 ga	8"	100
GPSF88ML	Galvanized 8 x 8 PB Step Flashing	Mill	30 ga	8"	100
LPSF457ML	Galvalume 4 x 5 x 7 PB Step Flashing	Mill	26 ga	7"	25
CPSF57	Copper 5 x 7 PB Step Flashing	Copper	10 oz	7"	Order by the pc.
CPSF88	Copper 8 x 8 PB Step Flashing	Copper	10 oz	8"	Order by the pc.
CPSF914	Copper 9 x 14 PB Step Flashing	Copper	10 oz	14"	Order by the pc.

APSF237

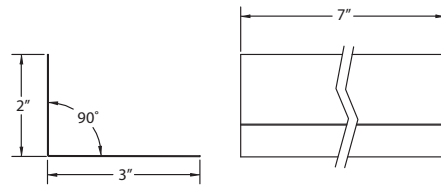

APSF57, GPSF57, CPSF57

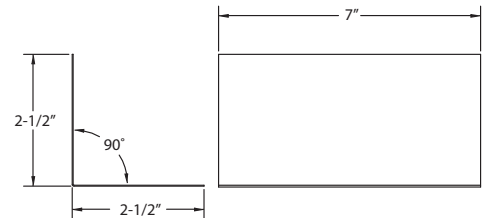

APSF347, GPSF347

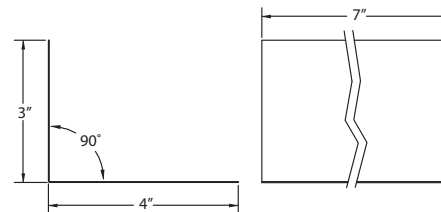

APSF557

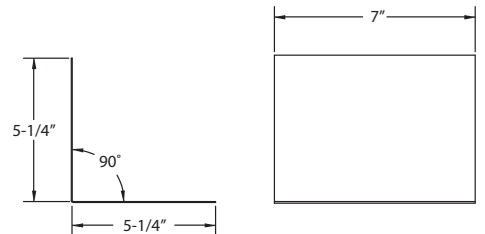

APSF558

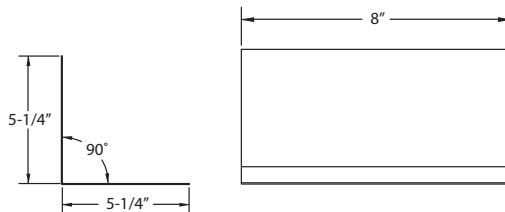

APSF88, GPSF88, CPSF88

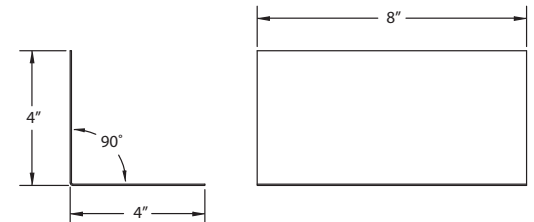

ALUMINUM Roofing Accessories Colors:

COLOR	CODE	COLOR	CODE	COLOR	CODE
BLACK	BK	ROYAL BROWN	RB	TERRA BRONZE	TB

Rain Diverter

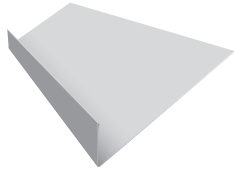

Part #	Description	Colors	Nom. Gauge/ Thickness	Piece Length	Pieces/ Bundle	Bundles/ Pallet	Pieces/ Pallet
GRD824 - -	Galvanized 2 x 4 Rain Diverter	BK, RB, TB	28 ga	10'	25	20	500
GRD824ML	Galvanized 2 x 4 Rain Diverter	Mill	28 ga	10'	25	20	500
GRD2626ML	Galvanized 2 x 6 Rain Diverter	Mill	26 ga	10'	25	20	500
GRD710 - -	Galvanized 7" Rain Diverter	BK, RB	26 ga	10'	10	25	250
GRD710ML	Galvanized 7" Rain Diverter	Mill	26 ga	10'	10	25	250

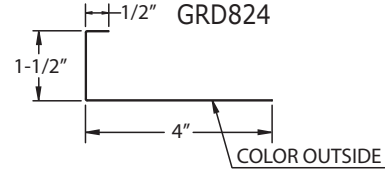
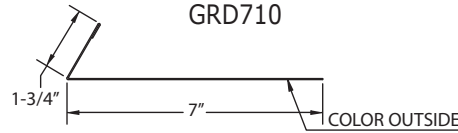

Reglet Flashing

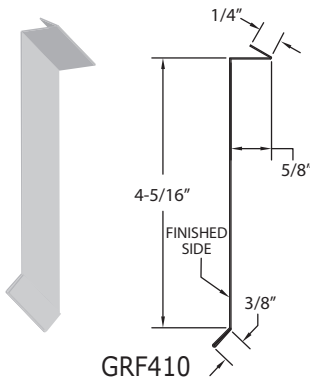

Part #	Description	Colors	Nom. Gauge/ Thickness	Piece Length	Pieces/ Box	Boxes/ Pallet	Pieces/ Pallet
GRF410 - -	Galvanized 4" Reglet Flashing	BK, RB, TB	26 ga	10'	10	25	250
GRF410ML	Galvanized 4" Reglet Flashing	Mill	26 ga	10'	10	25	250

Counter Flashing



Part #	Description	Colors	Nom. Gauge/ Thickness	Piece Length	Pieces/ Box
GCF30610 - -	Galvanized 6" Counter Flashing	BK, BR, WB	28 ga	10'	25
GCF566ML	Galvanized 6" Counter Flashing	Mill	26 ga	10'	1

Philly Flashing



Part #	Description	Colors	Nom. Gauge/ Thickness	Piece Length	Pieces/ Bundle	Boxes/ Pallet	Pieces/ Pallet
LPHF310ML	Galvalume 3" Philly Flashing	Mill	26 ga	10'	20	20	400

J-Flashing

Part #	Description	Colors	Nom. Gauge/ Thickness	Pieces/ Box
GJF28445ML	Galvanized 4 x 4-1/2 x 1/2 J-Flashing	Mill	28 ga	25

Roll Valley



Part #	Description	Colors	Nom. Gauge/ Thickness	Piece Length	Pieces/ Box	Boxes/ Pallet	Pieces/ Pallet
ARV10ML	Aluminum 10" Roll Valley	Mill	0.011	50'	1	25	25
ARV12ML	Aluminum 12" Roll Valley	Mill	0.011	50'	1	25	25
ARV14ML	Aluminum 14" Roll Valley	Mill	0.011	50'	1	25	25
ARV20ML	Aluminum 20" Roll Valley	Mill	0.011	50'	1	25	25

STEEL Roofing Accessories Colors:

COLOR	CODE	COLOR	CODE	COLOR	CODE
BLACK	BK	ROYAL BROWN	RB	TERRA BRONZE	TB

Roll Valley cont.



Part #	Description	Colors	Nom. Gauge/ Thickness	Piece Length	Pieces/ Box	Boxes/ Pallet	Pieces/ Pallet
GRV26125ML	Galvanized 12" Roll Valley	Mill	26 ga	50'	1	50	50
GRV26205ML	Galvanized 20" Roll Valley	Mill	26 ga	50'	1	50	50
GRV8ML	Galvanized 8" Roll Valley	Mill	32 ga	50'	1	25	25
GRV10ML	Galvanized 10" Roll Valley	Mill	32 ga	50'	1	25	25
GRV12ML	Galvanized 12" Roll Valley	Mill	32 ga	50'	1	25	25
GRV14ML	Galvanized 14" Roll Valley	Mill	32 ga	50'	1	25	25
GRV20ML	Galvanized 20" Roll Valley	Mill	32 ga	50'	1	25	25
GRV24ML	Galvanized 24" Roll Valley	Mill	32 ga	50'	1	25	25
GRV30105ML	Galvanized 10" x 50' Std. Roll Valley	Mill	30 ga	50'	1	50	50
GRV30125ML	Galvanized 12" x 50' Std. Roll Valley	Mill	30 ga	50'	1	50	50
GRV30165ML	Galvanized 16" x 50' Std. Roll Valley	Mill	30 ga	50'	1	50	50
GRV30185ML	Galvanized 18" x 50' Std. Roll Valley	Mill	30 ga	50'	1	50	50
GRV30245ML	Galvanized 24" x 50' Std. Roll Valley	Mill	30 ga	50'	1	50	50
LRV26165GL	Galvalume 16" Roll Valley	Mill	26 ga	50'	1	50	50
CRV112	Copper 12" Roll Valley 100 lb	Copper	16 oz	100'	Order by the pc.		
CRV116	Copper 16" Roll Valley 80 lb	Copper	16 oz	60'	Order by the pc.		
CRV120	Copper 20" Roll Valley 100 lb	Copper	16 oz	60'	Order by the pc.		
CRV124	Copper 24" Roll Valley 100 lb	Copper	16 oz	50'	Order by the pc.		

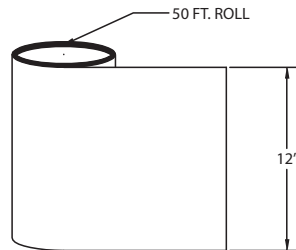

ARV12ML, GRV12ML

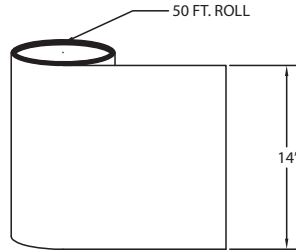

ARV14ML, GRV14ML

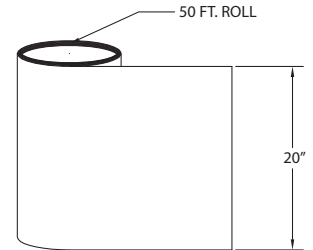

ARV20ML, GRV20ML

W-Valley

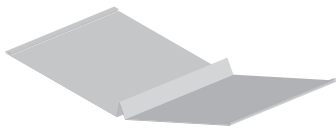

Part #	Description	Colors	Nom. Gauge/ Thickness	Piece Length	Pieces/ Bundle	Pieces/ Pallet
AWV24 - -	Aluminum 24" W-Valley	BK, BZ, RB, TB	0.019	10'	100	100
GFVA2615ML	Galvanized 15" Formed A	Mill	26 ga	10'	Order by the pc.	
GPV2618ML	Galvanized 18" Preformed W-Valley	Mill	26 ga	10'	Order by the pc.	
GPV2620ML	Galvanized 20" Preformed W-Valley	Mill	26 ga	10'	Order by the pc.	
GWV2620 - -	Galvanized 20" Water Brake W-Valley	BK, RB, WW	26 ga	10'	50	100
GWV2620ML	Galvanized 20" Water Brake W-Valley	Mill	26 ga	10'	50	100
GWV2620 - -	Galvanized 20" W-Valley	BK, RB, WW	26 ga	10'	100	100
GWV20 - -	Galvanized 20" Water Brake W-Valley	BR, WB	30 ga	10'	50	100
GWV18 - -	Galvanized 18" W-Valley	BK, RB, TB	30 ga	10'	100	100
GWV20TB	Galvanized 20" W-Valley	TB	30 ga	10'	100	100
LTV24ML	Galvalume 24" Tile Valley	Mill	26 ga	10'	25	200
LTVH24ML	Galvalume 24" Tile Valley w/Hem	Mill	26 ga	10'	25	100
CWV18	Copper 18" W-Valley	Copper	16 oz	10'	Order by the pc.	
CWV24	Copper 24" W-Valley	Copper	16 oz	10'	Order by the pc.	

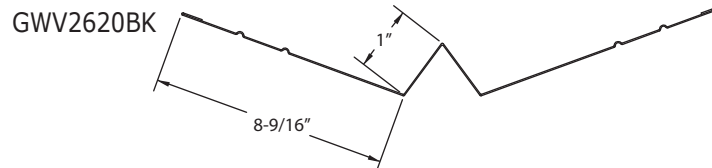

ALUMINUM Roofing Accessories Colors:

COLOR	CODE	COLOR	CODE	COLOR	CODE	COLOR	CODE
BLACK	BK	BRONZE	BZ	ROYAL BROWN	RB	TERRA BRONZE	TB

STEEL Roofing Accessories Colors:

COLOR	CODE	COLOR	CODE	COLOR	CODE	COLOR	CODE
BLACK	BK	ROYAL BROWN	RB	WEATHERED BRONZE	WB	WEATHERWOOD	WW
BROWN	BR	TERRA BRONZE	TB				

Roof to Wall Flashing

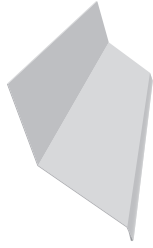

Part #	Description	Colors	Nom. Gauge/ Thickness	Piece Length	Pieces/ Box	Boxes/ Pallet	Pieces/ Pallet
ARTW4410 - -	Aluminum 4 x 4 R/W Flashing	BK, TB	0.019	10'	25	25	625
GRTW3310 - -	Galvanized 3 x 3 R/W Flashing	BK, RB, TB, WH	26 ga	10'	10	10	250
GRTW4410ML	Galvanized 4 x 4 R/W Flashing	Mill	26 ga	10'	10	10	250
LRTWFML	Galvalume Tile Roof Wall Flashing	Mill	26 ga	10'	10	10	100

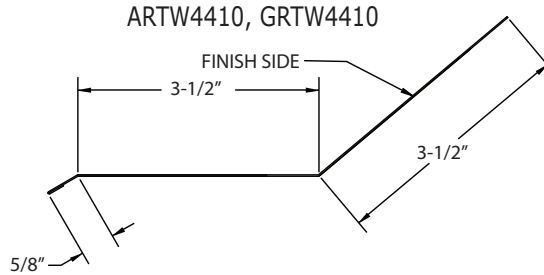

Sidewall Flashing

Part #	Description	Colors	Nom. Gauge/ Thickness	Piece Length	Pieces/ Box	Boxes/ Pallet	Pieces/ Pallet
ASWF4410TB	Alum. 4 x 4 X 10 Side Wall Flashing	TB	0.019	10'	10	14	140
GOW84455ML	Galv. 4 x 4-1/2 X 1/2 O/W Flashing	Mill	28 ga	10'	10	35	350
GSWF4410ML	Galv. 4 X 4 X 10 Side Wall Flashing	Mill	26 ga	10'	10	35	250350

Flat Sheet

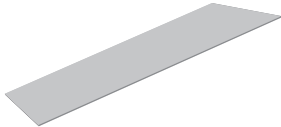

Part #	Description	Colors	Nom. Gauge/ Thickness	Piece Length	Pieces/ Box	Pieces/ Pallet
CFS3610	Copper 36" x 10' Flat Sheet	Copper	16 oz	10'	Order by the pc.	36

Flat Shingle



Part #	Description	Colors	Nom. Gauge/ Thickness	Piece Length	Pieces/ Bundle
GSF57ML	Galvanized 5 x 7 Flat Shingle	Mill	30 ga	7"	100
GSF88ML	Galvanized 8 x 8 Flat Shingle	Mill	30 ga	8"	100

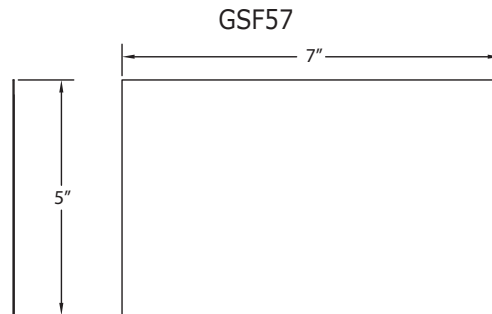

ALUMINUM Roofing Accessories Colors:

COLOR	CODE	COLOR	CODE
BLACK	BK	TERRA BRONZE	TB

STEEL Roofing Accessories Colors:

COLOR	CODE	COLOR	CODE	COLOR	CODE	COLOR	CODE
BLACK	BK	ROYAL BROWN	RB	TERRA BRONZE	TB	WHITE	WH

Tile Ridge Cap Riser

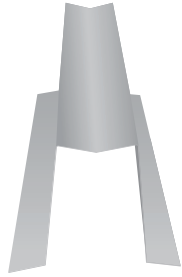

Part #	Description	Colors	Nom. Gauge/ Thickness	Piece Length	Pieces/ Bundle	Pieces/ Pallet
LR3R3ML	Galvalume 3" Tile Ridge Cap Riser	Mill	26 ga	10'	15	75
LR3R4ML	Galvalume 4" Tile Ridge Cap Riser	Mill	26 ga	10'	15	75
LR3R5ML	Galvalume 5" Tile Ridge Cap Riser	Mill	26 ga	10'	15	75
LR3R6ML	Galvalume 6" Tile Ridge Cap Riser	Mill	26 ga	10'	15	75

Kick Plate Channel (Roll Form)

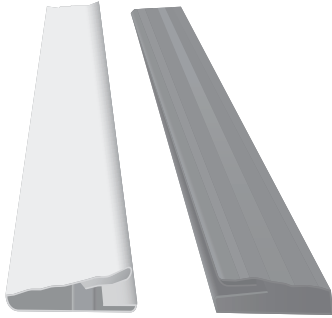

Part #	Description	Colors	Nom. Gauge/ Thickness	Piece Length	Pieces/ Bundle
AKP10 - -	Aluminum 10' Kick Plate Channel	TBZ, T80	0.024	10'	25
AKP12 - -	Aluminum 12' Kick Plate Channel	TBZ, T80	0.024	12'	25

Finish Trim

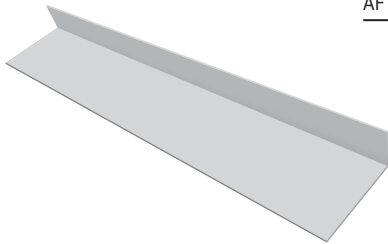

Part #	Description	Colors	Nom. Gauge/ Thickness	Piece Length	Pieces/ Bundle
AFTWH	Alum. 1 x 2 x 11-7/8 Finish Trim	WH	0.030	11-7/8"	25

Aluminum Patio Accessories Colors:

COLOR	CODE	COLOR	CODE	COLOR	CODE
TAMPA BRONZE	TBZ	TAMPA 80 WHITE	T80	WHITE	WH

ROOFING *Accessories*



**ACM is a “one stop shop”
manufacturing system for all
your exterior metal products.**

ACM manufactures rainware, edge metals, trim coil, soffit and fascia, and siding accessories. We are constantly upgrading our plants and machinery to improve quality, add additional profiles, and create new innovative products.

**Aluminum is made with majority of
post consumer waste.**

Aluminum and steel are recyclable, aluminum even more so. Did you know that Aluminum can be recycled over and over again? 75% of all aluminum ever smelted is still being recycled.

We keep Green Circle Certificates on hand for your access proving that 75% more of our raw material comes from recycled consumer waste. You may use this information to advertise that you are a “Green” company or as back-up documentation for government projects.

For Customer Service: 800-749-4067



ROOFING *Accessories*

Apollo Beach Plant Coverage Region

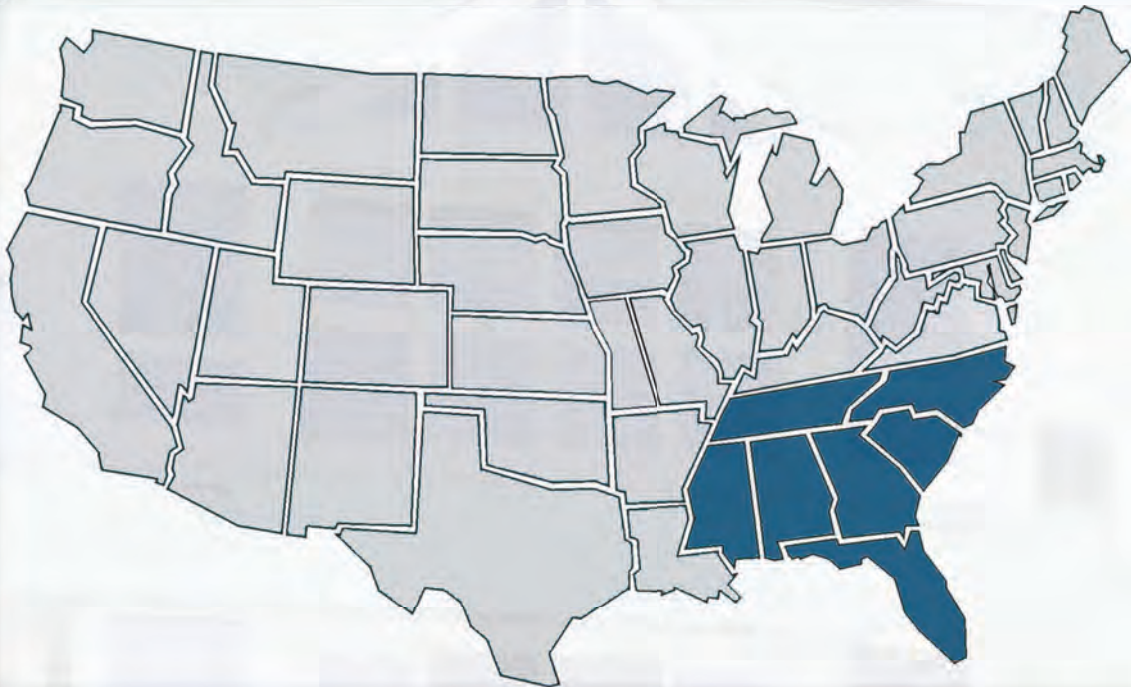

Customer Service: Ph 800-749-4067 • Fax 608-364-0598
www.acm-metals.com