

ROOFING *Accessories*



2019 Shawnee Plant
PRODUCT CATALOG

www.acm-metals.com

2019 Shawnee Plant
**ROOFING ACCESSORIES
CATALOG**

Table of Contents

Angle Flashing	2	Gravel Stop	7
Standard	2	Gutter Apron	7
No Kick (Color Outside)	2	Rain Diverter	9
No Kick (Color Inside)	2	Reglet Flashing	9
Colorado Drip Edge	3	Counter Flashing	9
C-Channel	3	T-Bar	10
Drip Edge	4-6	Flat Sheet	10
Professional (Closed Face)	4	Flat Shingle	10
Standard (Closed Face)	4	Pre-Bent Step Flashing	11-12
Professional (Open Face)	5	Roll Valley	13
F-8 Large (Open Face).....	5	Roof to Wall Flashing	14
26 Gauge Galvanized (Open Face)	5	Side Wall Flashing	14
Builders.....	6	Tile Pan Flashing	14
Economy	6	W-Valley & W-Valley Professional	15
Drip Edge/Eave	6		
Rake Edge 90°	6-7		
Professional	6		
Professional 2-3/4" Back Crown Face.....	6		
Standard	7		

PROUDLY FINISHED WITH
SHERWIN-WILLIAMS
Coil Coatings

We reserve the right to change the content of product offerings at any time. Please consult the online catalog at www.acm-metals.com for the most update product offering.

Contact Information:

CUSTOMER SERVICE: Ph 877-279-5096 • Fax 608-365-0493
www.acm-metals.com



Angle Flashing

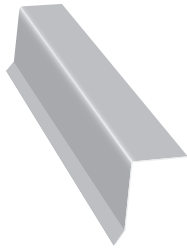

Part #	Description	Colors	Nom. Gauge/ Thickness	Piece Length	Pieces/ Box	Boxes/ Pallet	Pieces/ Pallet
Standard							
AAF2210 - -	Alum. 2 x 2 Std. Angle Flash. (C4)	RB, WH	0.019	10'	25	35	875
AAF32531WH	Alum. 2-5/8 x 3 Std. Angle Flash.	WH	0.032	10'	25	35	875
AAF3310 - -	Alum. 3 x 3 Std. Angle Flash. (C5-1/2)	BK, RB, WH	0.019	10'	25	35	875
AAF33310 - -	Alum. 3 x 3 Std. Angle Flash. (C6)	RB, WH	0.032	10'	25	35	875
AAF33310ML	Alum. 3 x 3 Std. Angle Flash. (C6)	Mill	0.032	10'	25	35	875
GAF25410WH	Galv. 2-1/2 x 4 Std. Angle Flash.	WH	26 ga	10'	10	35	350
GAF25410ML	Galv. 2-1/2 x 4 Std. Angle Flash.	Mill	26 ga	10'	10	35	350
GAF3310 - -	Galv. 3 x 3 Std. Angle Flash. (C6)	BK, RB, TB, WH	26 ga	10'	10	35	350
GAF3310ML	Galv. 3 x 3 Std. Angle Flash. (C6)	Mill	26 ga	10'	10	35	350
GAF4410 - -	Galv. 4 x 4 Std. Angle Flash. (C7)	BK, RB, TB, WH	26 ga	10'	10	35	350
GAF4410ML	Galv. 4 x 4 Std. Angle Flash. (C7)	Mill	26 ga	10'	10	35	350
GAF6610 - -	Galv. 6 x 6 Std. Angle Flash.	BK, RB, TB, WH	26 ga	10'	10	35	350

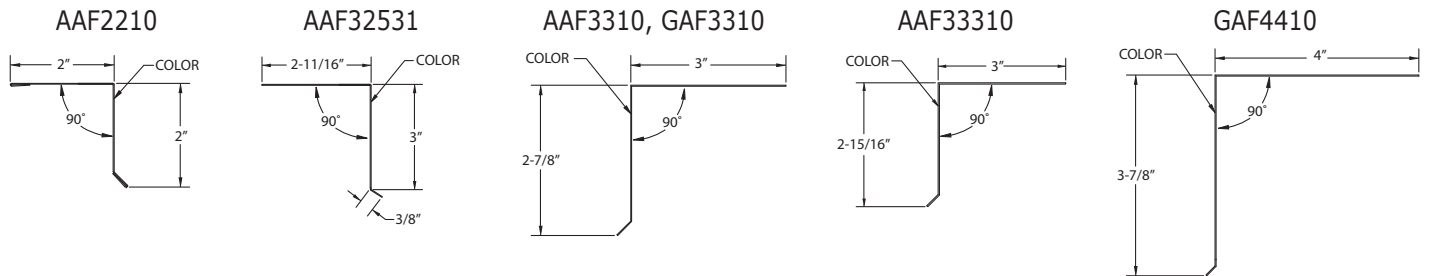

No Kick (Color Outside)

AAFN2210 - -	Alum. 2 x 2 N/K Angle Flash.	RB, WH	0.019	10'	10	35	350
AAFN3310WH	Alum. 3 x 3 N/K Angle Flash. (E6)	WH	0.019	10'	10	35	350
GAFN3310 - -	Galv. 3 x 3 N/K Angle Flash. (E6)	RB, WH	26 ga	10'	10	35	350
GAFN3310ML	Galv. 3 x 3 N/K Angle Flash. (E6)	Mill	26 ga	10'	10	35	350
GAFN4410 - -	Galv. 4 x 4 N/K Angle Flash. (E8)	BK, RB, TB, WH	26 ga	10'	10	35	350
GAFN4410ML	Galv. 4 x 4 N/K Angle Flash. (E8)	Mill	26 ga	10'	10	35	350
GAFN845 - -	Galv. 4 x 5 N/K Angle Flash.	RB, WH	28 ga	10'	10	35	350
GAFN845ML	Galv. 4 x 5 N/K Angle Flash.	Mill	28 ga	10'	10	35	350
GAFN8452 - -	Galv. 4 x 5 N/K Angle Flash. 120°	RB, WH	28 ga	10'	10	35	350
GAFN8452ML	Galv. 4 x 5 N/K Angle Flash. 120°	Mill	28 ga	10'	10	35	350

AAFN3310, GAFN3310

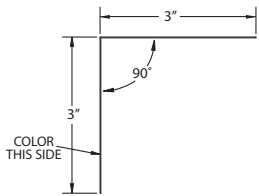

GAFN4410

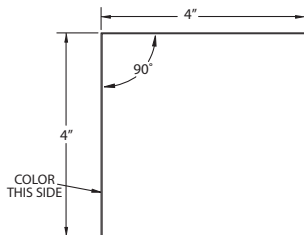

No Kick (Color Inside)

GAFNR331 - -	Galv. 3 x 3 N/K Angle Flash. Rev. Color (E8)	BK, TB	26 ga	10'	10	35	350
GAFNR441 - -	Galv. 4 x 4 N/K Angle Flash. Rev. Color (E8)	BK, TB	26 ga	10'	10	35	350
GAFNR441ML	Galv. 4 x 4 N/K Angle Flash. Rev. Color (E8)	Mill	26 ga	10'	10	35	350
GAFNR845 - -	Galv. 4 x 5 N/K Angle Flash. Rev. Color (E8)	RB, WH	26 ga	10'	10	35	350
GAFNR845ML	Galv. 4 x 5 N/K Angle Flash. Rev. Color (E8)	Mill	26 ga	10'	10	35	350

GAFN845

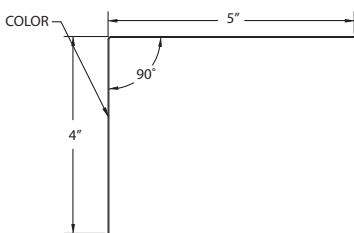

GAFN8452

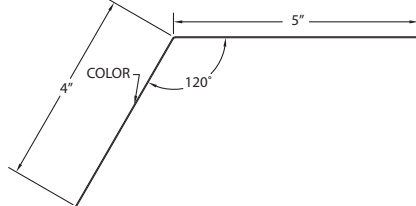

GAFNR331

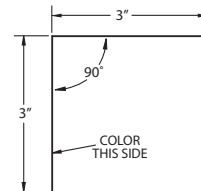

GAFNR441

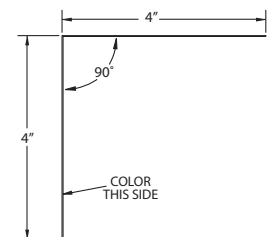

Roofing Accessories Colors:

COLOR	CODE	COLOR	CODE	COLOR	CODE	COLOR	CODE
BLACK	BK	ROYAL BROWN	RB	TERRA BRONZE	TB	WHITE	WH

Colorado Drip Edge

Part #	Description	Colors	Nom. Gauge/ Thickness	Piece Length	Pieces/ Bundle	Bundles/ Pallet	Pieces/ Pallet
GDE822	Galv. 2 x 2, 90° Dual Safety Hem DE	(Listed Below)	28 ga	10'	10	68	680
GDE822ML	Galv. 2 x 2, 90° Dual Safety Hem DE	Mill	28 ga	10'	10	68	680
GDE8222	Galv. 2 x 2, 120° Dual Safety Hem DE	(Listed Below)	28 ga	10'	10	68	680
GDE8222ML	Galv. 2 x 2, 120° Dual Safety Hem DE	Mill	28 ga	10'	10	68	680
GDE824	Galv. 2 x 4, 90° Dual Safety Hem DE	(Listed Below)	28 ga	10'	10	40	400
GDE824ML	Galv. 2 x 4, 90° Dual Safety Hem DE	Mill	28 ga	10'	10	40	400
GDE8242	Galv. 2 x 4, 120° Dual Safety Hem DE	(Listed Below)	28 ga	10'	10	40	400
GDE8242ML	Galv. 2 x 4, 120° Dual Safety Hem DE	Mill	28 ga	10'	10	40	400

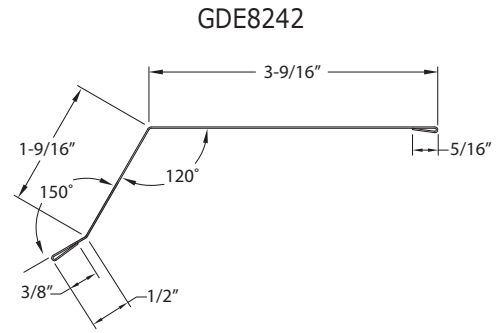
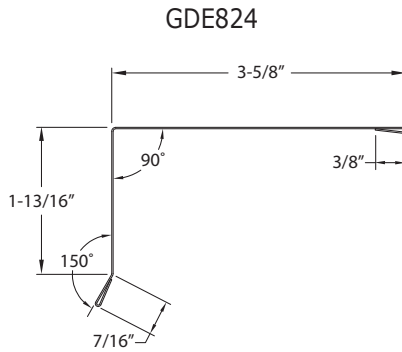
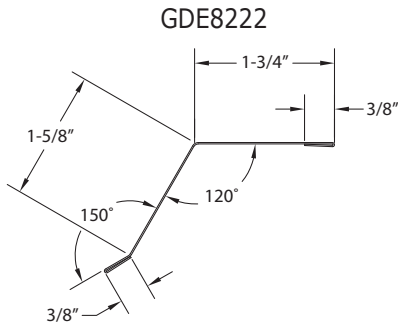
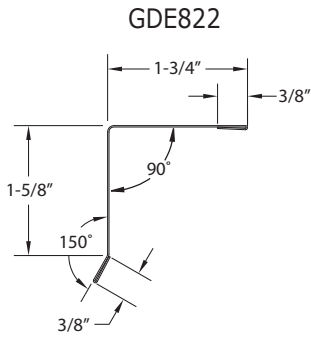

C-Channel

Part #	Description	Colors	Nom. Gauge/ Thickness	Piece Length	Pieces/ Box	Boxes/ Pallet	Pieces/ Pallet
ACC10	Alum. 1" C-Channel	BK, RB, TB, WH	0.019	10'	25	24	600
ACC15	Alum. 1-1/2" C-Channel	BK, RB, TB, WH	0.019	10'	25	24	600
ACC20	Alum. 2" C-Channel	BK, RB, TB, WH	0.019	10'	25	12	300
GCC10	Galv. 1" C-Channel	BK, RB, TB, WH	28 ga	10'	25	24	600
GCC10ML	Galv. 1" C-Channel	Mill	28 ga	10'	25	24	600
GCC15	Galv. 1-1/2" C-Channel	BK, RB, TB, WH	28 ga	10'	25	24	600
GCC20	Galv. 2" C-Channel	BK, RB, TB, WH	28 ga	10'	25	24	600
GCC20ML	Galv. 2" C-Channel	Mill	28 ga	10'	25	24	600

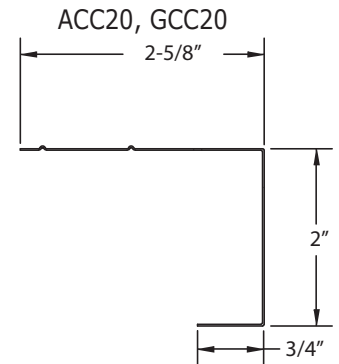
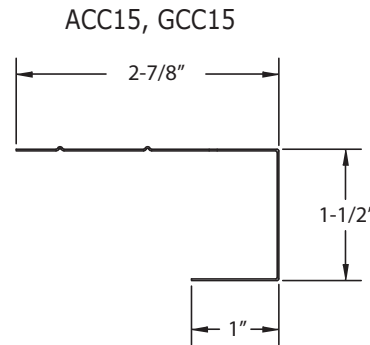
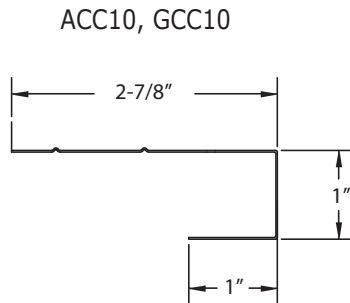

Roofing Accessories Colors:

COLOR	CODE	COLOR	CODE	COLOR	CODE	COLOR	CODE
BLACK	BK	EVERGREEN	EG	ROYAL BROWN	RB	TERRA BRONZE	TB
CHARCOAL GREY	CG	HARBOR GREY	HG	REDWOOD	RW	WHITE	WH
COUNTRY BLUE	CU						

Drip Edge

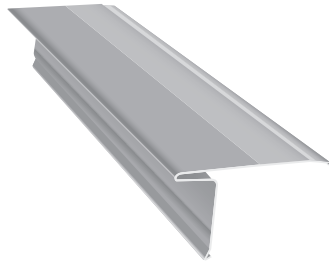

Part #	Description	Colors	Nom. Gauge/ Thickness	Piece Length	Pieces/ Box	Boxes/ Pallet	Pieces/ Pallet
Professional - Closed Face							
• ADE10 - -	Alum. 1" Face w/2-7/8" Back DE (F5)	(Listed Below)	0.019	10'	50	24	1200
*Also available in Montana Suede XMS.							
• ADE15 - -	Alum. 1-1/2" Face w/3" Back DE	(Listed Below)	0.019	10'	50	24	1200
ADE15ML	Alum. 1-1/2" Face w/3" Back DE	Mill	0.019	10'	50	24	1200
• ADE185 - -	Alum. 1-3/4" Face w/2-5/16" Back DE	(Listed Below)	0.019	10'	50	24	1200
ADE185ML	Alum. 1-3/4" Face w/2-5/16" Back DE	Mill	0.019	10'	50	24	1200
ADE2415WH	Alum. 1-1/2" Face w/3" Back DE	WH	0.024	10'	25	24	600
GDE10 - -	Galv. 1" Face w/2-7/8" Back DE (F5)	BK, RB, TB, WH	28 ga	10'	25	24	600
GDE10ML	Galv. 1" Face w/2-7/8" Back DE (F5)	Mill	28 ga	10'	25	24	600
GDE15 - -	Galv. 1-1/2" Face w/3" Back DE	BK, RB, TB, WH	28 ga	10'	25	24	600
GDE15ML	Galv. 1-1/2" Face w/3" Back DE	Mill	28 ga	10'	25	24	600
GDE20 - -	Galv. 2" Face w/3" Back DE (ODE)	BK, RB, TB, WH	28 ga	10'	25	24	600
GDE20ML	Galv. 2" Face w/3" Back DE(ODE)	Mill	28 ga	10'	25	24	600
GDE2610 - -	Galv. 1" Closed Face w/2-7/8" Back DE	BK, NW, RB, TB, WH	26 ga	10'	20	24	480
GDE2615 - -	Galv. 1-1/2" Closed Face w/2-7/8" Back DE	BK, NW, RB, TB, WH	26 ga	10'	20	18	480
GDE2615ML	Galv. 1-1/2" Closed Face w/2-7/8" Back DE	Mill	26 ga	10'	20	18	480
GDE2622ML	Galv. 2 x 2 Closed Face DE	Mill	26 ga	10'	25	18	240
CDE10	Copper 1" Face w/2-7/8" Back DE	Copper	10 oz	10'	10	Order by the pc.	
CDE15	Copper 1-1/2" Face w/3" Back DE	Copper	10 oz	10'	10	Order by the pc.	

ADE10, GDE10, CDE10

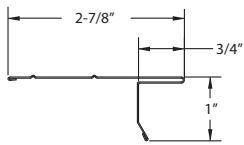

ADE15, GDE15, CDE15

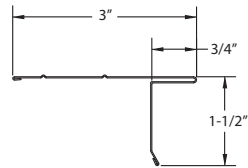

ADE2415

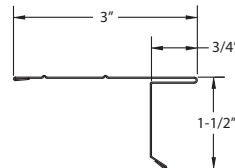

GDE20

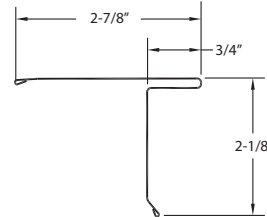

ADE185

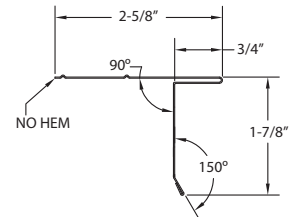

Standard - Closed Face

ESADE10 - -	Econ. Alum. 1" Face DE (FSN4-1/2)	RB, TB, WH	0.015	10'	50	24	1200
SADE10 - -	Alum. 1" Face DE (F4-1/2)	BK, RB, TB, WH	0.019	10'	50	24	1200
SADE125 - -	Alum. 1-1/4" Face DE	BK, MB, RB, TB, VG, WH	0.019	10'	50	24	1200
SADE15 - -	Alum. 1-1/2" Face DE (F5M)	BK, RB, TB, WH	0.019	10'	50	24	1200
SADE15ML	Alum. 1-1/2" Face DE (F5M)	Mill	0.019	10'	50	24	1200
SADE185 - -	Alum. 1-3/4" Face DE (ODE)	AL, BZ, BK, CL, MB, MS, RB, TB, WH	0.019	10'	50	24	1200
SADE185ML	Alum. 1-3/4" Face DE (ODE)	Mill	0.019	10'	50	24	1200
SGDE10 - -	Galv. 1" Face DE (F4-1/2)	BK, RB, TB, WH	28 ga	10'	25	24	600
SGDE10ML	Galv. 1" Face DE (F4-1/2)	Mill	28 ga	10'	25	24	600
SGDE125 - -	Galv. 1-1/4" Face DE	BK, RB, TB, WH	28 ga	10'	25	24	600
SGDE125ML	Galv. 1-1/4" Face DE	Mill	28 ga	10'	25	24	600
SGDE15 - -	Galv. 1-1/2" Face DE (F5M)	BK, RB, TB, WH	28 ga	10'	25	24	600
SGDE15ML	Galv. 1-1/2" Face DE (F5M)	Mill	28 ga	10'	25	24	600
SGDE185 - -	Galv. 1-3/4" Face DE (ODE)	BK, RB, TB, WH	28 ga	10'	25	24	600
SGDE185ML	Galv. 1-3/4" Face DE (ODE)	Mill	28 ga	10'	25	24	600

SADE10, SGDE10

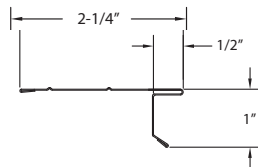

SADE125, SGDE125

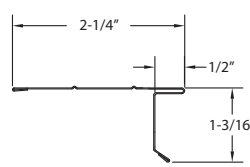

SADE15, SGDE15

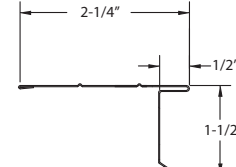

SADE185, SGDE185

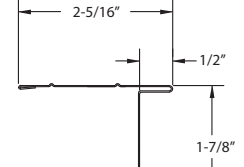

Roofing Accessories Colors / • = Color-Thru System™

COLOR	CODE	COLOR	CODE	COLOR	CODE	COLOR	CODE	COLOR	CODE
• NX ALMOND	D49	• NX CHAMPAGNE	D53	• EVERGREEN	EG	• PEBBLESTONE CLAY	PC	• NX SIERRA	D47
• ALMOND	AL	• CHARCOAL GREY	CG	• NX GRANITE	A19	• REDWOOD	RW	SILVER GREY	SG
• BEAVER BROWN	BB	• CLASSIC CREAM	CC	• HARBOR GREY	HG	• NX RUSSET	B18	• NX TAN	D48
• BLACK	BK	• CLAY	CL	• NX LINEN	W10	• ROYAL BROWN	RB	• TERRA BRONZE	TB
• BRONZE	BZ	• COUNTRY BLUE	CU	• LINEN	LI	SAGE	SA	• VICTORIAN GREY	VG
• BROOKSTONE	BS	• DESERT SAND	DS	MONTANA SUEDE	MS	• NX SAND	D51	• WHITE	WH
• BUCKSKIN	BU	• NX DUNE	D54	• MUSKET BROWN	MB	• NX SAND STONE	D46	• WICKER	WI
• CAMEO	CA	• EVEREST	EV	• NORWEGIAN WOOD	NW	• SANDTONE	ST		

Drip Edge cont.

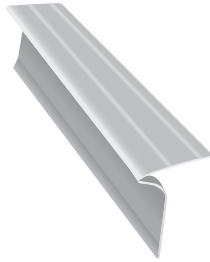

Part #	Description	Colors	Nom. Gauge/ Thickness	Piece Length	Pieces/ Box	Boxes/ Pallet	Pieces/ Pallet
Professional - Open Face							
ADEOF10 - -	Alum. 1-1/2" Open Face w/3-3/4" Back DE (F5-1/20)	BK, RB, TB, WH	0.019	10'	50	24	1200
ADEOF10ML	Alum. 1-1/2" Open Face w/3-3/4" Back DE (F5-1/20)	Mill	0.019	10'	50	24	1200
ADEOF415 - -	Alum. 1-1/2" Open Face w/2-3/8" Back DE (F50)	BK, RB, TB, WH	0.019	10'	50	24	1200
ADEOF415ML	Alum. 1-1/2" Open Face w/2-3/8" Back DE (F50)	Mill	0.019	10'	50	24	1200
<hr/>							
GDEOF10 - -	Galv. 1-1/2" Open Face w/3-3/4" Back DE (F5-1/20)	RB, WH	28 ga	10'	25	32	800
GDEOF10ML	Galv. 1-1/2" Open Face w/3-3/4" Back DE (F5-1/20)	Mill	28 ga	10'	25	32	800
GDEOF415 - -	Galv. 1-1/2" Open Face w/2-3/8" Back DE (F50)	BK, RB, TB, WH	28 ga	10'	25	32	800
GDEOF415ML	Galv. 1-1/2" Open Face w/2-3/8" Back DE (F50)	Mill	28 ga	10'	25	32	800

ADEOF10, GDEOF10

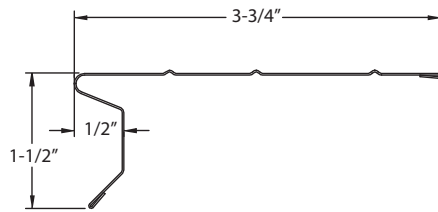

ADEOF415, GDEOF415

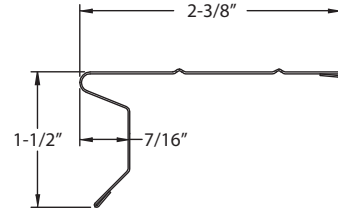

F-8 Large - Open Face

EAEF8 - -	Econ. Alum. 1-1/2" Open Face DE (F8)	RB, WH	0.015	10'	25	24	600
ADEF8 - -	Alum. 1-1/2" Open Face w/5-3/4" Back DE (F8)	BK, RB, TB, WH	0.019	10'	25	24	600
ADEF8ML	Alum. 1-1/2" Open Face w/5-3/4" Back DE (F8)	Mill	0.019	10'	25	24	600
<hr/>							
GDEF8 - -	Galv. 1-1/2" Open Face w/5-3/4" Back DE (F8)	BK, RB, TB, WH	28 ga	10'	15	24	360
GDEF8ML	Galv. 1-1/2" Open Face w/5-3/4" Back DE (F8)	Mill	28 ga	10'	15	24	360

EAEF8, ADEF8, GDEF8

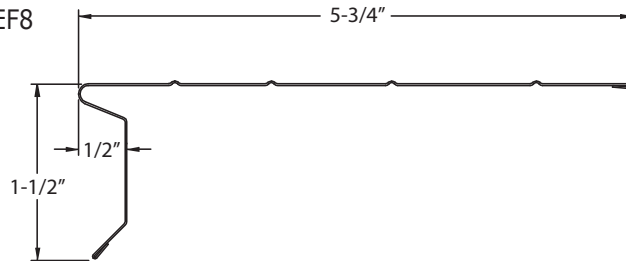

26 Gauge Galvanized - Open Face

GDEOF615 - -	Galv. 2" Open Face w/3-1/2" Back DE	BK, RB, TB, WH	26 ga	10'	20	24	480
GDEOF615ML	Galv. 2" Open Face w/3-1/2" Back DE	Mill	26 ga	10'	20	24	480
GDEOF625 - -	Galv. 2-3/4" Open Face w/2-5/8" Back DE	BK, RB, TB, WH	26 ga	10'	20	24	480
GDEOF625ML	Galv. 2-3/4" Open Face w/2-5/8" Back DE	Mill	26 ga	10'	20	24	480
GDEOF630 - -	Galv. 3-1/4" Open Face w/2-9/16" Back DE	BK, RB, TB, WH	26 ga	10'	20	24	480
GDEOF630ML	Galv. 3-1/4" Open Face w/2-9/16" Back DE	Mill	26 ga	10'	20	24	480

GDEOF615

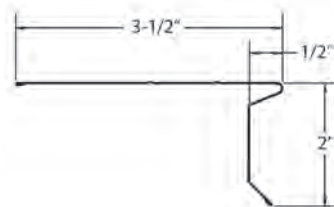

GDEOF625

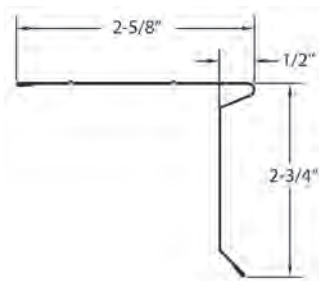

GDEOF630

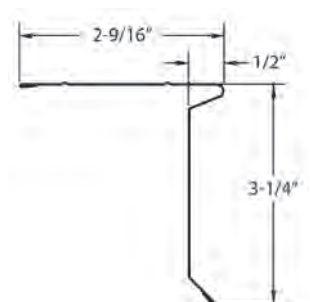

Roofing Accessories Colors:

COLOR	CODE	COLOR	CODE	COLOR	CODE	COLOR	CODE
BLACK	BK	ROYAL BROWN	RB	TERRA BRONZE	TB	WHITE	WH

Drip Edge cont.

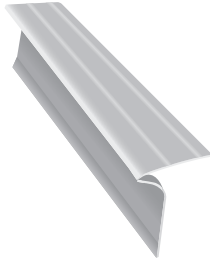

Part #	Description	Colors	Nom. Gauge/ Thickness	Piece Length	Pieces/ Bundle	Pieces/ Pallet
Builders						
BADE10 - -	Alum. 1" Builders DE (F5)	RB, WH	0.019	10'	50	24 1200
BADEOF10 - -	Alum. 1" Builders Open Face DE (F5-1/20)	RB, WH	0.019	10'	50	24 1200
BADEOF41 - -	Alum. 1" Builders Open Face DE (F50)	RB, WH	0.019	10'	50	24 1200
BSADE10 - -	Alum. 1" Builders DE (F4-1/2)	RB, WH	0.019	10'	50	24 1200
BSADE15 - -	Alum. 1-1/2" Builders DE (F5M)	RB, WH	0.019	10'	50	24 1200
Economy						
EADEOF41 - -	Econ. Alum. 1" Open Face DE (F50)	BK, RB, WH	0.015	10'	50	12 600

Drip Edge / Eave

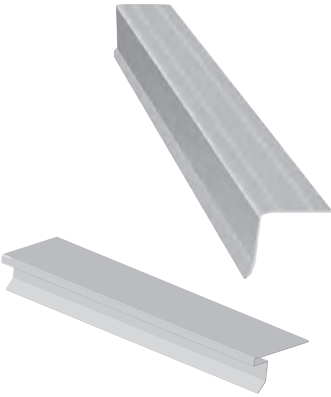

Part #	Description	Colors	Nom. Gauge/ Thickness	Piece Length	Pieces/ Bundle	Pieces/ Pallet
GDE2633ML	Galv. 3 x 3 Press Brake Eave	Mill	26 ga	10'	25	1500
GDE2844ML	Galv. 4 x 4 Press Brake Eave	Mill	28 ga	10'	25	2250
GDE3012 - -	Galv. 1 x 2 Eave	WH	30 ga	10'	25	1500
GDE3022 - -	Galv. 2 x 2 Eave	BK, RB, TB, WH	30 ga	10'	25	2250
GDE3022ML	Galv. 2 x 2 Standard Roof Edge	Mill	30 ga	10'	25	2250
GDE3212ML	Galv. 1 x 2 x 10' Econ. Roof Edge	Mill	32 ga	10'	25	2250
GDEDL30 - -	Galv. DL Long Eave	BK, RB, TB, WH	30 ga	10'	25	1500
GDEDL30ML	Galv. DL Long Premium Eave	Mill	30 ga	10'	25	1500
GDEDLW30 - -	Galv. DL Long Woodgrain Eave	BK, RB, TB, WH	30 ga	10'	25	1500
GDEDW30 - -	Galv. DL Short Woodgrain Eave	BK, RB, TB, WH	30 ga	10'	25	1500
GDEW3022 - -	Galv. 2 x 2 Woodgrain Eave	BK, RB, TB, WH	30 ga	10'	25	1500
GEE112 - -	Galv. 1-1/2 Econ. Eave	BK, RB, TB, WH	32 ga	10'	25	2500

GDE2633ML

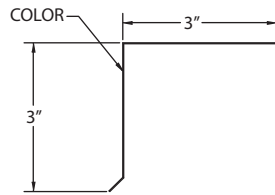

GDE2844ML

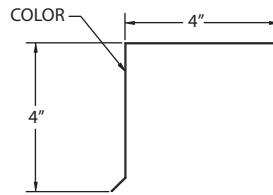

GDE3012

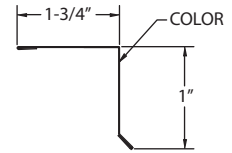

GDE3022, GDE3022ML

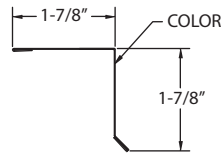

GDEDL30, GDEDL30ML

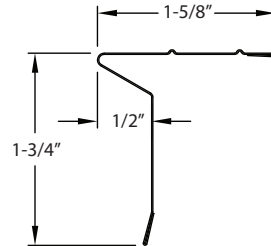

GDEDW30

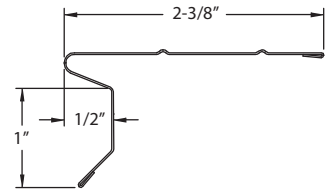

GDEW3022

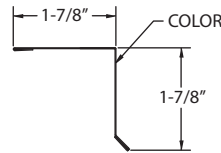

GEE112

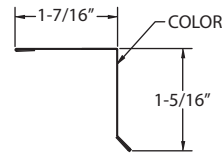

Roofing Accessories Colors:

COLOR	CODE	COLOR	CODE	COLOR	CODE	COLOR	CODE
BLACK	BK	ROYAL BROWN	RB	TERRA BRONZE	TB	WHITE	WH

Rake Edge 90°

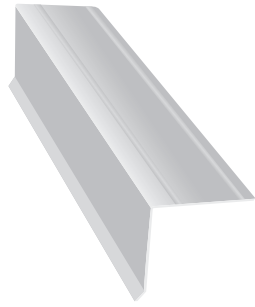

Part #	Description	Colors	Nom. Gauge/ Thickness	Piece Length	Pieces/ Box	Boxes/ Pallet	Pieces/ Pallet
--------	-------------	--------	-----------------------	--------------	-------------	---------------	----------------

Professional

EARKC315 - -	Econ. Alum. 1-1/2" Crown Fc w/2-3/16" Back (C3-1/2)	RB, WH	0.015	10'	50	32	1600
ARK15 - -	Alum. 1-1/2" Face w/2-11/16" Back DE	BK, RB, TB, WH	0.019	10'	50	32	1600
ARK25 - -	Alum. 2-1/2" Face w/2-7/16" Back DE (C5-1/2)	RB, WH	0.019	10'	50	32	1600
ARKC315 - -	Alum. 1-1/2" Crown Fc w/2-3/16" Back DE (C3-1/2)	RB, WH	0.019	10'	50	32	1600
GRK10 - -	Galv. 1" Face w/2-3/4" Back DE	BK, RB, TB, WH	28 ga	10'	25	32	800
GRK10ML	Galv. 1" Face w/2-3/4" Back DE	Mill	28 ga	10'	25	32	800
GRK15 - -	Galv. 1-1/2" Face w/2-11/16" Back DE	BK, RB, TB, WH	28 ga	10'	25	32	800
GRK15ML	Galv. 1-1/2" Face w/2-11/16" Back DE	Mill	28 ga	10'	25	32	800
GRK25 - -	Galv. 2-1/2" Face w/2-7/16" Back DE (C5-1/2)	BK, RB, TB, WH	28 ga	10'	25	32	800
GRK25ML	Galv. 2-1/2" Face w/2-7/16" Back DE (C5-1/2)	Mill	28 ga	10'	25	32	800

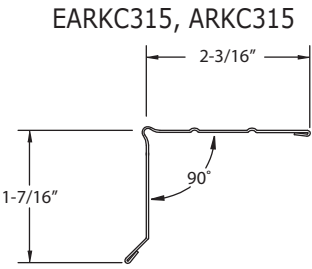

ARK15, GRK15

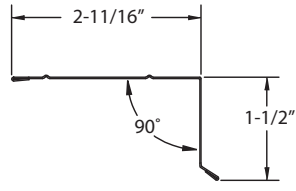

ARK25, GRK25

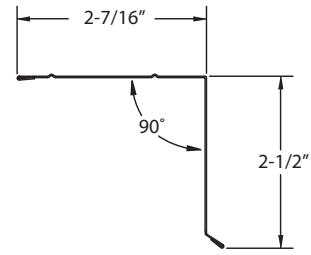

GRK10

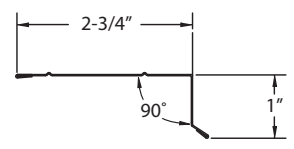

Professional 2-3/4" Back Crown Face

ARKC415 - -	Alum. 1-1/2" Crown Face DE (C4-1/2)	RB, WH	0.019	10'	50	32	1600
ARKC415ML	Alum. 1-1/2" Crown Face DE (C4-1/2)	Mill	0.019	10'	50	32	1600

ARKC415

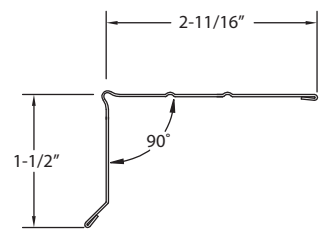

Standard

SARK10 - -	Alum. 1" Std. Face w/1-11/16" Back DE	BK, RB, TB, WH	0.019	10'	50	32	1600
SARK20 - -	Alum. 2" Std. Face w/1-7/8" Back DE (C4)	BK, RB, TB, WH	0.019	10'	50	32	1600
SARK25 - -	Alum. 2-1/2" Std. Face w/2-1/16" Back DE	RB, WH	0.019	10'	50	32	1600
SGRK10 - -	Galv. 1" Std. Face w/1-11/16" Back DE	BK, RB, TB, WH	28 ga	10'	25	32	800
SGRK10ML	Galv. 1" Std. Face w/1-11/16" Back DE	Mill	28 ga	10'	25	32	800
SGRK20 - -	Galv. 2" Std. Face w/1-7/8" Back DE (C4)	BK, RB, TB, WH	28 ga	10'	25	32	800
SGRK20ML	Galv. 2" Std. Face w/1-7/8" Back DE (C4)	Mill	28 ga	10'	25	32	800

SARK10, SGRK10

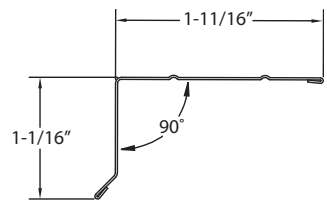

SARK20, SGRK20

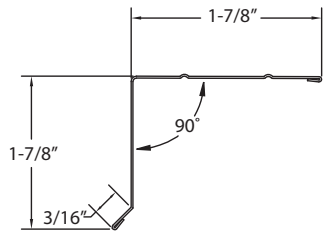

SARK25

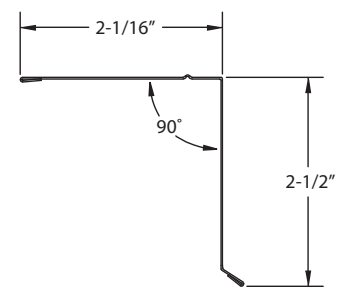

Roofing Accessories Colors:

COLOR	CODE	COLOR	CODE	COLOR	CODE	COLOR	CODE
BLACK	BK	ROYAL BROWN	RB	TERRA BRONZE	TB	WHITE	WH

Gravel Stop



Part #	Description	Colors	Nom. Gauge/ Thickness	Piece Length	Pieces/ Box	Boxes/ Pallet	Pieces/ Pallet
AGS30 - -	Alum. 3" Face Gravel Stop (H6F)	BK, RB, TB, WH	0.019	10'	25	20	500
AGS40 - -	Alum. 4" Face Gravel Stop (H7)	BK, RB, TB, WH	0.019	10'	25	20	500
AGS340 - -	Alum. 4" Face Gravel Stop (H7)	BK, RB, TB, WH	0.032	10'	25	20	500
GGS30 - -	Galv. 3" Face Gravel Stop (H6F)	BK, RB, TB, WH	26 ga	10'	10	35	350
GGS30ML	Galv. 3" Face Gravel Stop (H6F)	Mill	26 ga	10'	10	35	350
GGS40 - -	Galv. 4" Face Gravel Stop (H7)	BK, RB, TB, WH	26 ga	10'	10	35	350
GGS40ML	Galv. 4" Face Gravel Stop (H7)	Mill	26 ga	10'	10	35	350
GGS644ML	Galv. 4 x 4 Face Gravel Stop	Mill	26 ga	10'	10	35	350

AGS30, GGS30

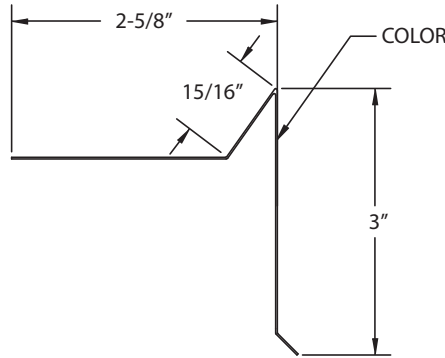

AGS40, GGS40

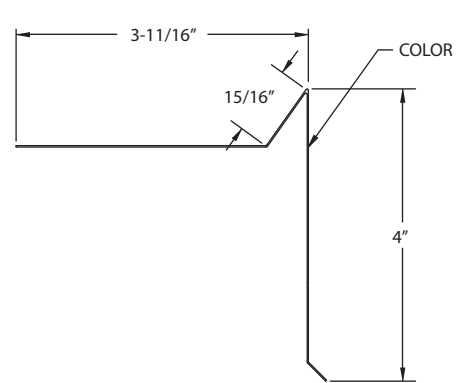

Gutter Apron



Part #	Description	Colors	Nom. Gauge/ Thickness	Piece Length	Pieces/ Box	Boxes/ Pallet	Pieces/ Pallet
AGA15 - -	Alum. 1-1/2" Face Gutter Apron	BK, RB, TB, WH	0.019	10'	50	32	1600
AGA20 - -	Alum. 2" Face Gutter Apron	(Listed Below)	0.019	10'	50	32	1600
GGA15 - -	Galv. 1-1/2" Face Gutter Apron	BK, RB, TB, WH	28 ga	10'	25	32	600
GGA15ML	Galv. 1-1/2" Face Gutter Apron	Mill	28 ga	10'	25	32	600
GGA20 - -	Galv. 2" Face Gutter Apron	BK, RB, TB, WH	28 ga	10'	25	32	600
GGA20ML	Galv. 2" Face Gutter Apron	Mill	28 ga	10'	25	32	600
GGA2620 - -	Galv. 2" Face Gutter Apron	BK, NW, RB, TB, WH	26 ga	10'	25	32	600
CGA20	Copper 2" Face Gutter Apron	Copper	10 oz	10'	Order by the pc.		

AGA15, GGA15

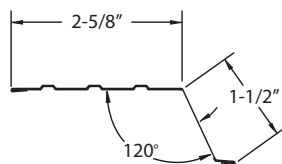

AGA20, GGA20

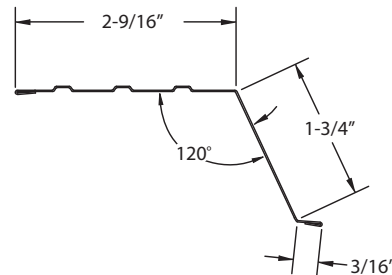

Roofing Accessories Colors / ●=ACM Color-Thru System™

COLOR	CODE	COLOR	CODE	COLOR	CODE	COLOR	CODE	COLOR	CODE
● ALMOND	AL	● CAMEO	CA	● EVEREST	EV	● NORWEGIAN WOOD	NW	● SILVER GREY	SG
● BEAVER BROWN	BB	● CHARCOAL GREY	CG	● EVERGREEN	EG	● PEBBLESTONE CLAY	PC	● TERRA BRONZE	TB
● BLACK	BK	● CLASSIC CREAM	CC	● HARBOR GREY	HG	● REDWOOD	RW	● VICTORIAN GREY	VG
● BRONZE	BZ	● CLAY	CL	● LINEN	LI	● ROYAL BROWN	RB	● WHITE	WH
● BROOKSTONE	BS	● COUNTRY BLUE	CU	● MONTANA SUEDE	XMS	● SAGE	SA	● WICKER	WI
● BUCKSKIN	BU	● DESERT SAND	DS	● MUSKET BROWN	MB	● SANDTONE	ST		

Rain Diverter

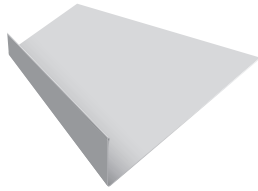

Part #	Description	Colors	Nom. Gauge/ Thickness	Piece Length	Pieces/ Box	Boxes/ Pallet	Pieces/ Pallet
GRD710 - -	Galv. 7" Rain Diverter	BK, RB, TB, WH	26 ga	10'	10	25	250
GRD710ML	Galv. 7" Rain Diverter	Mill	26 ga	10'	10	25	250

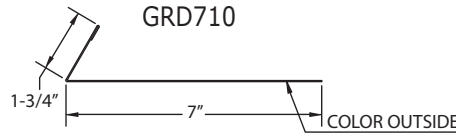

Reglet Flashing



Part #	Description	Colors	Nom. Gauge/ Thickness	Piece Length	Pieces/ Box	Boxes/ Pallet	Pieces/ Pallet
GRF410 - -	Galv. 4" Reglet Flashing	BK, RB, TB, WH	26 ga	10'	10	25	250
GRF410ML	Galv. 4" Reglet Flashing	Mill	26 ga	10'	10	25	250
CRF410	Copper 4" Reglet Flashing	Copper	16 oz	10'	Order by the pc.		

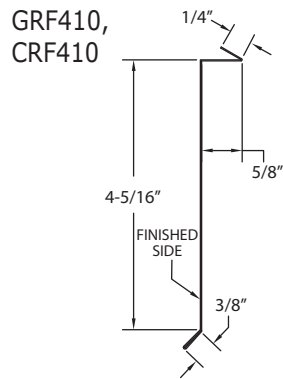

Counter Flashing



Part #	Description	Colors	Nom. Gauge/ Thickness	Piece Length	Pieces/ Box	Boxes/ Pallet	Pieces/ Pallet
GCFU645ML	Galv. 4 x 1/2" Counter Flashing Unit	BK, CG, HG, RB, WH	26 ga	10'	25	40	1000
GCF510 - -	Galv. 5 x 10 Counter Flashing	BK, CG, HG, RB, WH	28 ga	10'	10	25	250
GCF510ML	Galv. 5 x 10 Counter Flashing	Mill	28 ga	10'	10	25	250
GCF710ML	Galv. 7 x 10 Counter Flashing	Mill	26 ga	10'	10	25	250
GLCF510 - -	Galv. 5" Ledge Colorado Counter Flashing	CG, HG, RB, WH	28 ga	10'	10	25	250
GLCF510ML	Galv. 5" Ledge Colorado Counter Flashing	Mill	28 ga	10'	10	25	250

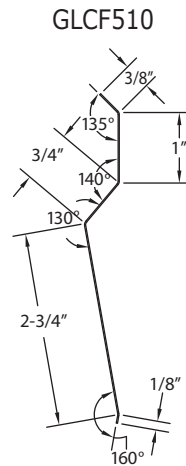
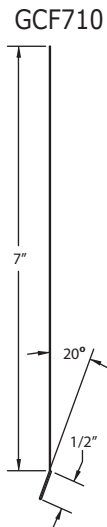
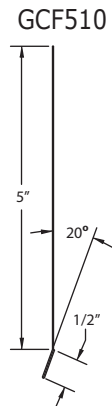

Roofing Accessories Colors:

COLOR	CODE	COLOR	CODE	COLOR	CODE	COLOR	CODE
BLACK	BK	HARBOR GREY	HG	TERRA BRONZE	TB	WHITE	WH
CHARCOAL GREY	CG	ROYAL BROWN	RB				

T-Bar



Part #	Description	Color	Nom. Gauge/ Thickness	Piece Length	Pieces/ Box
ATB10	Aluminum 10' T-Bar	Mill	0.050	10'	16

Flat Sheet

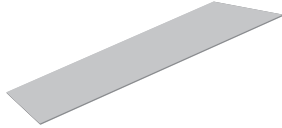

Part #	Description	Color	Nom. Gauge/ Thickness	Piece Length	Pieces/ Box
CFS2410	Copper 24" x 10' Flat Sheet	Copper	16 oz	10'	Order by the pc.
CFS3610	Copper 36" x 10' Flat Sheet	Copper	16 oz	10'	Order by the pc.

Flat Shingle



Part #	Description	Color	Nom. Gauge/ Thickness	Piece Length	Pieces/ Bundle	Pieces/ Box
ASF2885WH	Alum. 8 x 8 Flat Shingle	WH	0.024	8"	50	250
ASF57 - - - -	Alum. 5 x 7 Flat Shingle	BK/RB, TB/WH	0.011	7"	100	500
ASF57ML	Alum. 5 x 7 Flat Shingle	Mill	0.011	7"	100	500
ASF68 - - - -	Alum. 6 x 8 Flat Shingle	BK/RB, TB/WH	0.011	8"	100	500
ASF68ML	Alum. 6 x 8 Flat Shingle	Mill	0.011	8"	100	500
ASF710 - - - -	Alum. 7 x 10 Flat Shingle	BK/RB, TB/WH	0.011	10"	100	500
ASF710ML	Alum. 7 x 10 Flat Shingle	Mill	0.011	10"	100	500
ASF88 - - - -	Alum. 8 x 8 Flat Shingle	BK/RB, TB/WH	0.011	8"	100	500
ASF88ML	Alum. 8 x 8 Flat Shingle	Mill	0.011	8"	100	500
ASF810ML	Alum. 8 x 10 Flat Shingle	Mill	0.011	10"	100	500
GSF57ML	Galv. 5 x 7 Flat Shingle	Mill	30 ga	7"	100	
GSF68 - -	Galv. 6 x 8 Flat Shingle	BK, RB, TB	28 ga	8"	100	
GSF68ML	Galv. 6 x 8 Flat Shingle	Mill	28 ga	8"	100	
GSF88 - -	Galv. 8 x 8 Flat Shingle	BK, RB, TB, WH	28 ga	8"	100	
GSF88ML	Galv. 8 x 8 Flat Shingle	Mill	28 ga	8"	100	
GSF814 - -	Galv. 8 x 14 Flat Shingle	BK, RB, TB, WH	28 ga	14"	25	
GSF814ML	Galv. 8 x 14 Flat Shingle	Mill	28 ga	14"	25	
CSF57	Copper 5 x 7 Step Flashing	Copper	10 oz	7"	Order by the pc.	
CSF88	Copper 8 x 8 Step Flashing	Copper	10 oz	8"	Order by the pc.	
CSF814	Copper 8 x 14 Flat Shingle	Copper	10 oz	14"	Order by the pc.	

ASF57, GSF57, CSF57

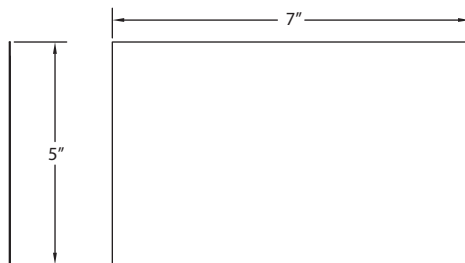

ASF68, GSF68

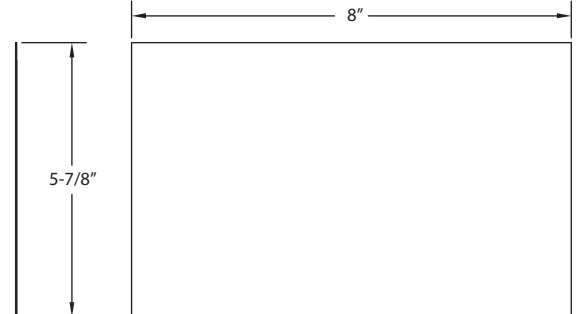

Roofing Accessories Colors:

COLOR	CODE	COLOR	CODE	COLOR	CODE	COLOR	CODE
BLACK	BK	ROYAL BROWN	RB	TERRA BRONZE	TB	WHITE	WH

Pre-Bent Step Flashing



Part #	Description	Color	Nom. Gauge/ Thickness	Piece Length	Pieces/ Bundle	Pieces/ Box
APSF2885 - -	Alum. 4 x 4 x 8 PB Step Flashing	BK, RB, WH	0.024	8"	50	250
APSF237 - -	Alum. 2 x 3 x 7 PB Step Flashing	BK, RB	0.011	7"	100	500
APSF237ML	Alum. 2 x 3 x 7 PB Step Flashing	Mill	0.011	7"	100	500
APSF57 - -	Alum. 2-1/2 x 2-1/2 x 7 PB SF	BK, RB, TB, WH	0.011	7"	100	500
APSF57ML	Alum. 2-1/2 x 2-1/2 x 7 PB SF	Mill	0.011	7"	100	500
APSF347 - -	Alum. 3 x 4 x 7 PB Step Flashing	BK, RB, TB	0.011	7"	100	500
APSF347ML	Alum. 3 x 4 x 7 PB Step Flashing	Mill	0.011	7"	100	500
APSF557 - -	Alum. 5 x 5 x 7 PB Step Flashing	BK, RB, TB	0.011	7"	100	500
APSF557ML	Alum. 5 x 5 x 7 PB Step Flashing	Mill	0.011	7"	100	500
APSF68 - -	Alum. 3 x 3 x 8 PB Step Flashing	BK, RB	0.011	8"	100	500
APSF68ML	Alum. 3 x 3 x 8 PB Step Flashing	Mill	0.011	8"	100	500
APSF88 - -	Alum. 4 x 4 x 8 PB Step Flashing	BK, RB, TB, WH	0.011	8"	100	500
APSF88ML	Alum. 4 x 4 x 8 PB Step Flashing	Mill	0.011	8"	100	500
APSF5585 - -	Alum. 5 x 5 x 8 PB Step Flashing	BK, RB	0.011	8"	50	250
APSF5585ML	Alum. 5 x 5 x 8 PB Step Flashing	Mill	0.011	8"	50	250
APSF558 - -	Alum. 5 x 5 x 8 PB Step Flashing	BK, RB	0.011	8"	100	500
APSF558ML	Alum. 5 x 5 x 8 PB Step Flashing	Mill	0.011	8"	100	500

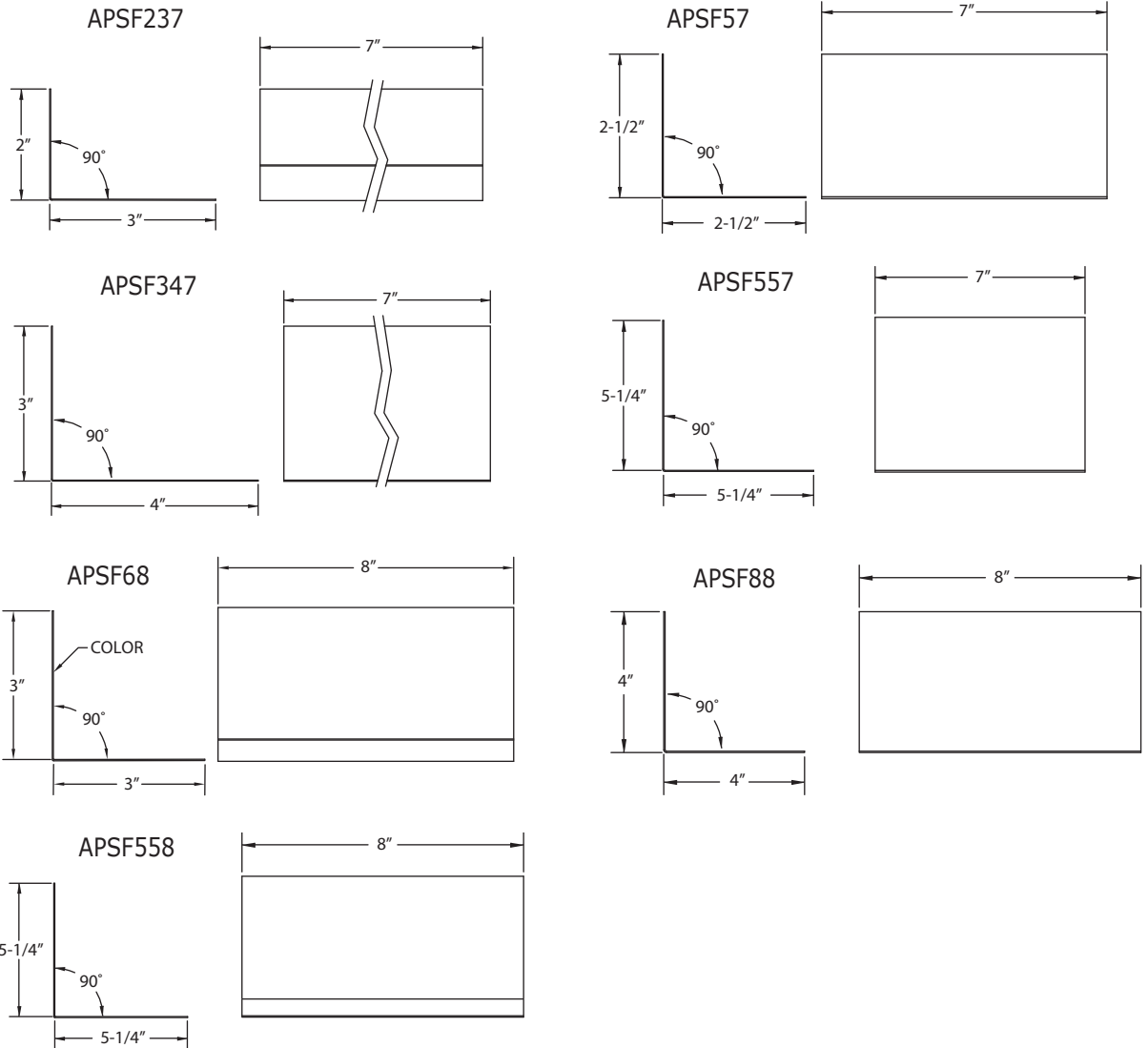

Roofing Accessories Colors:

COLOR	CODE	COLOR	CODE	COLOR	CODE	COLOR	CODE
BLACK	BK	ROYAL BROWN	RB	TERRA BRONZE	TB	WHITE	WH

Pre-Bent Step Flashing *cont.*



Part #	Description	Color	Nom. Gauge/ Thickness	Piece Length	Pieces/ Bundle
GPSF5512ML	Galv. 5 x 5 x 12 PB Step Flashing	Mill	30 ga	12"	100
GPSF57 - -	Galv. 2-1/2 x 2-1/2 x 7 PB Step Flashing	BK, RB, TB	28 ga	7"	100
GPSF57ML	Galv. 2-1/2 x 2-1/2 x 7 PB Step Flashing	Mill	28 ga	7"	100
GPSF88 - -	Galv. 4 x 4 x 8 PB Step Flashing	BK, RB, TB, WH	28 ga	8"	100
GPSF88ML	Galv. 4 x 4 x 8 PB Step Flashing	Mill	28 ga	8"	100
GPSF885 - -	Galv. 4 x 4 x 8 PB Step Flashing	BK, RB, TB	28 ga	8"	50
GPSF885ML	Galv. 4 x 4 x 8 PB Step Flashing	Mill	28 ga	8"	50
GPSF814 - -	Galv. 4 x 4 x 14 PB Step Flashing	BK, RB, TB, WH	28 ga	14"	25
GPSF814ML	Galv. 4 x 4 x 14 PB Step Flashing	Mill	28 ga	14"	25
GPSF914ML	Galv. 4 x 5 x 14 PB Step Flashing	Mill	28 ga	14"	25
CPSF57	Copper 2-1/2 x 2-1/2 x 7 PB Step Flashing	Copper	10 oz	7"	Order by the pc.
CPSF88	Copper 4 x 4 x 8 PB Step Flashing	Copper	10 oz	8"	Order by the pc.
CPSF814	Copper 4 x 4 x 14 PB Step Flashing	Copper	10 oz	14"	Order by the pc.
CPSF914	Copper 4 x 5 x 14 PB Step Flashing	Copper	10 oz	14"	Order by the pc.

GPSF57, CPSF57

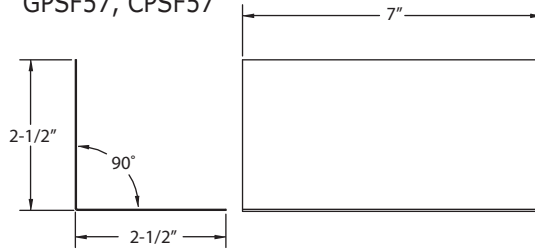

GPSF88

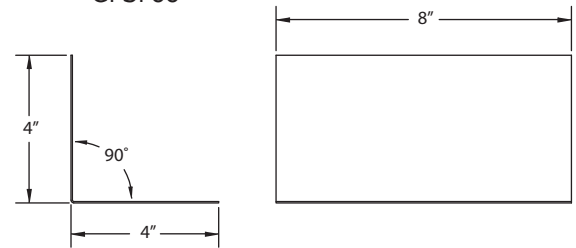

GPSF814, CPSF814

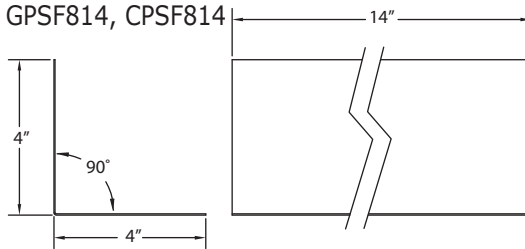

GPSF914, CPSF914

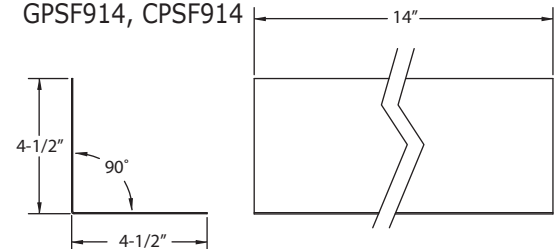

Roofing Accessories Colors:

COLOR	CODE	COLOR	CODE	COLOR	CODE	COLOR	CODE
BLACK	BK	ROYAL BROWN	RB	TERRA BRONZE	TB	WHITE	WH

Roll Valley



Part #	Description	Colors	Nom. Gauge/ Thickness	Piece Length	Pieces/ Box	Boxes/ Pallet	Pieces/ Pallet
ARV6ML	Alum. 6" Roll Valley	Mill	0.011	50'	1	25	25
ARV8ML	Alum. 8" Roll Valley	Mill	0.011	50'	1	25	25
ARV10ML	Alum. 10" Roll Valley	Mill	0.011	50'	1	25	25
ARV12ML	Alum. 12" Roll Valley	Mill	0.011	50'	1	25	25
ARV14ML	Alum. 14" Roll Valley	Mill	0.011	50'	1	25	25
ARV20ML	Alum. 20" Roll Valley	Mill	0.011	50'	1	25	25
GRV4ML	Galv. 4" Roll Valley	Mill	32 ga	50'	1	25	25
GRV6 - -	Galv. 6" Roll Valley	RB, TB	32 ga	50'	1	25	25
GRV6ML	Galv. 6" Roll Valley	Mill	32 ga	50'	1	25	25
GRV8 - -	Galv. 8" Roll Valley	RB, TB	32 ga	50'	1	25	25
GRV8ML	Galv. 8" Roll Valley	Mill	32 ga	50'	1	25	25
GRV10 - -	Galv. 10" Roll Valley	BK, RB, TB	32 ga	50'	1	25	25
GRV10ML	Galv. 10" Roll Valley	Mill	32 ga	50'	1	25	25
GRV102 - -	Galv. 10" Roll Valley	BK, TB	32 ga	25'	1	25	25
GRV12ML	Galv. 12" Roll Valley	Mill	32 ga	50'	1	25	25
GRV14ML	Galv. 14" Roll Valley	Mill	32 ga	50'	1	25	25
GRV16ML	Galv. 16" Roll Valley	Mill	32 ga	50'	1	25	25
GRV20 - -	Galv. 20" Roll Valley	BK, RB, TB	32 ga	50'	1	25	25
GRV20ML	Galv. 20" Roll Valley	Mill	32 ga	50'	1	25	25
GRV24ML	Galv. 24" Roll Valley	Mill	32 ga	50'	1	25	25
CRV112	Copper 12" Roll Valley 100# Roll	Copper	16 oz	100'	Order by the pc.		
CRV114	Copper 14" Roll Valley 100# Roll	Copper	10 oz	85'	Order by the pc.		
CRV116	Copper 16" Roll Valley 80# Roll	Copper	10 oz	60'	Order by the pc.		
CRV120	Copper 20" Roll Valley 100# Roll	Copper	10 oz	60'	Order by the pc.		
CRV124	Copper 24" Roll Valley 100# Roll	Copper	16 oz	50'	Order by the pc.		

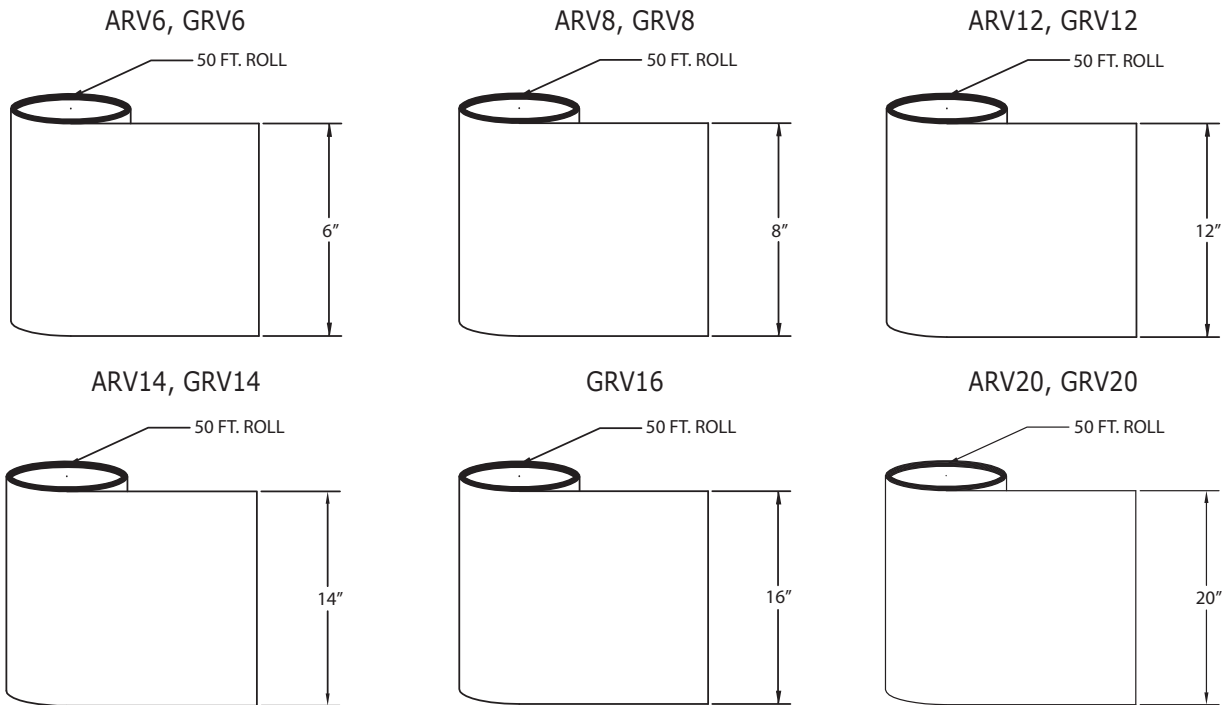

Roofing Accessories Colors:

COLOR	CODE	COLOR	CODE	COLOR	CODE
BLACK	BK	ROYAL BROWN	RB	TERRA BRONZE	TB

Roof to Wall Flashing

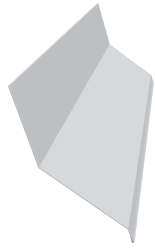

Part #	Description	Color	Nom. Gauge/ Thickness	Piece Length	Pieces/ Box	Boxes/ Pallet	Pieces/ Pallet
ARTW3310 --	Alum. 3 x 3 R/W Flashing	BK, RB, TB, WH	0.019	10'	25	25	625
ARTW4410 --	Alum. 4 x 4 R/W Flashing	BK, RB, TB, WH	0.019	10'	25	25	625
GRTW3310 --	Galv. 3 x 3 R/W Flashing	BK, RB, TB, WH	26 ga	10'	10	25	250
GRTW3310ML	Galv. 3 x 3 R/W Flashing	Mill	26 ga	10'	10	25	250
GRTW4410 --	Galv. 4 x 4 R/W Flashing	BK, RB, TB, WH	26 ga	10'	10	25	250
GRTW4410ML	Galv. 4 x 4 R/W Flashing	Mill	26 ga	10'	10	25	250
CRTW4410	Copper 4 x 4 R/W Flashing	Copper	16 oz	10'	Order by the pc.		

ARTW3310, GRTW3310

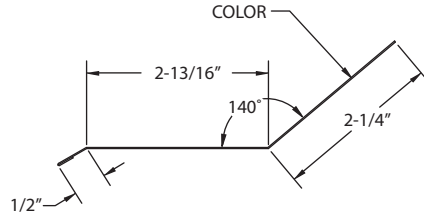

ARTW4410, GRTW4410, CRTW4410

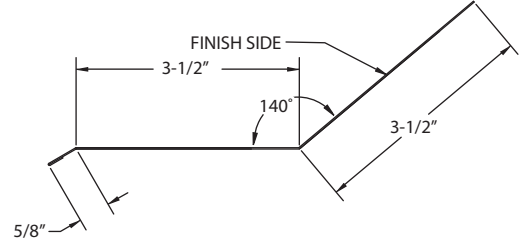

Side Wall Flashing



Part #	Description	Color	Nom. Gauge/ Thickness	Piece Length	Pieces/ Box	Boxes/ Pallet	Pieces/ Pallet
ASWF4410 --	Alum. 4 x 4 S/W Flashing	BK, RB, TB, WH	0.019	10'	10	14	140
GSWF4410 --	Galv. 4 x 4 S/W Flashing	RB, TB, WH	26 ga	10'	10	35	350
GSWF4410ML	Galv. 4 x 4 S/W Flashing	Mill	26 ga	10'	10	35	350
GSWF5710 --	Galv. 5 x 7 S/W Flashing	BK, WH	26 ga	10'	10	35	350

ASWF4410, GSWF4410

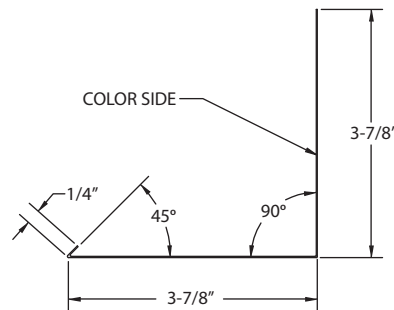

GSWF5710

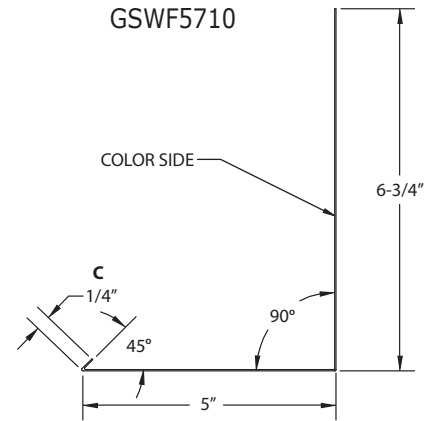

Tile Pan Flashing



Part #	Description	Color	Nom. Gauge/ Thickness	Piece Length	Pieces/ Box	Boxes/ Pallet	Pieces/ Pallet
GTP6561ML	Galv. 5 x 6 x 1 Tile Pan	Mill	26 ga	10'	10	35	350

GTP6561ML

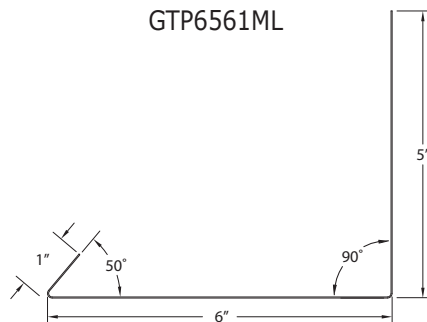

W-Valley

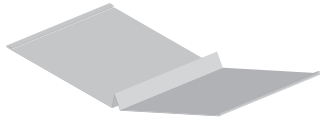

Part #	Description	Colors	Nom. Gauge/ Thickness	Piece Length	Pieces/ Box	Pieces/ Pallet
AWV24 - -	Alum. 24" W-Valley	BK, BZ, RB, TB	0.019	10'		100
AWV224 - -	Alum. 24" W-Valley	BK, RB, MB, WH	0.024	10'		100
GWV18 - -	Galv. 18" W-Valley	BK, RB, TB, WH	30 ga	10'		100
GWV20 - -	Galv. 20" W-Valley	BK, RB, TB, WH	30 ga	10'		100
GWV20ML	Galv. 20" W-Valley	Mill	30 ga	10'		100
GWVA20 - -	Galv. 20" "A" W-Valley	BK, BR, WB	30 ga	10'	100	200
CWV18	Copper 18" W-Valley	Copper	16 oz	10'	Order by the pc.	
CWV24	Copper 24" W-Valley	Copper	16 oz	10'	Order by the pc.	

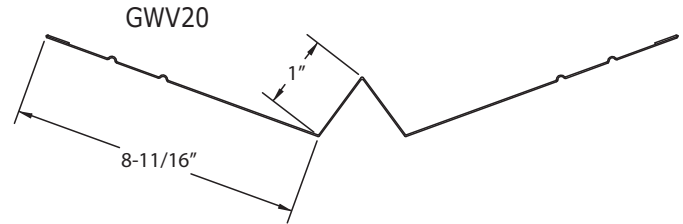
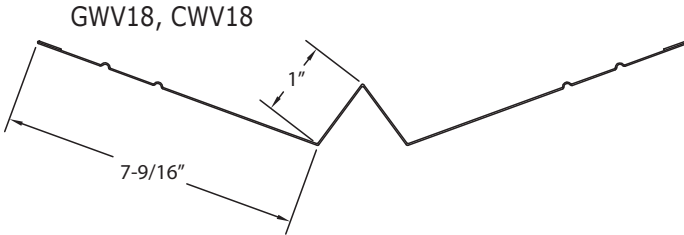

W-Valley - Professional



Part #	Description	Colors	Nom. Gauge/ Thickness	Piece Length	Pieces/ Pallet
GWV2620 - -	Galv. 20" Prof. W-Valley	BK, RB, TB	26 ga	10'	100
GWV2624 - -	Galv. 24" Prof. W-Valley	BK, RB, TB	26 ga	10'	100
GWV2624ML	Galv. 24" Prof. W-Valley	Mill	26 ga	10'	100
GWV2820 - -	Galv. 20" Prof. W-Valley	BK, RB, TB	28 ga	10'	100
GWV24 - -	Galv. 24" Prof. W-Valley	BK, RB, TB, WH	28 ga	10'	100
GWV24ML	Galv. 24" Prof. W-Valley	Mill	28 ga	10'	100

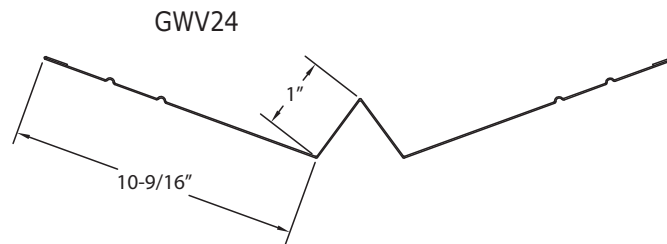
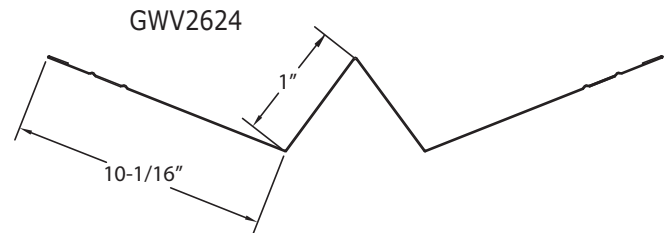
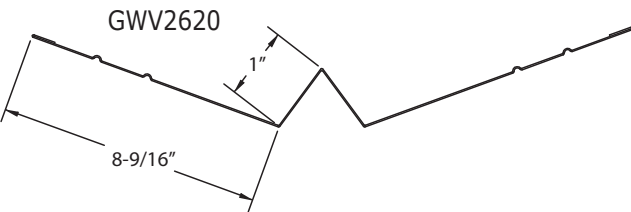

Roofing Accessories Colors:

COLOR	CODE	COLOR	CODE	COLOR	CODE	COLOR	CODE
BLACK	BK	ROYAL BROWN	RB	TERRA BRONZE	TB	WHITE	WH
BRONZE	BZ						

ROOFING *Accessories*



ACM is a "one stop shop" manufacturing system for your exterior metal products.

ACM manufactures rainware, edge metals, trim coil, soffit and fascia, and siding accessories. We are constantly upgrading our plants and machinery to improve quality, add additional profiles, and create new innovative products.

Homeowners want consistent color matches for their soffit and fascia, rainware, edge metals, trim coil, and siding accessories.

Some contractors buy gutter coil, soffit and fascia, edge metals, etc., from a wide variety of manufacturers and supply centers to get the lowest cost. The end result is that their components don't quite match and now it's permanently spoiled the appearance of the home.

Our **Color-Thru System™** has 24 colors to which you can match all parts of the house. You can use this system of colors to help you sell more jobs. The homeowner will see more value in your proposal if you can provide accurate color matches on all parts of the house.

Aluminum is made with majority of post consumer waste.

Aluminum and steel are recyclable, aluminum even more so. Did you know that Aluminum can be recycled over and over again? 75% of all aluminum ever smelted is still being recycled.

We keep Green Circle Certificates on hand for your access proving that 75% more of our raw material comes from recycled consumer waste. You may use this information to advertise that you are a "Green" company or as back-up documentation for government projects.

For Customer Service: 877-279-5096



ROOFING *Accessories*

Shawnee Plant Coverage Region

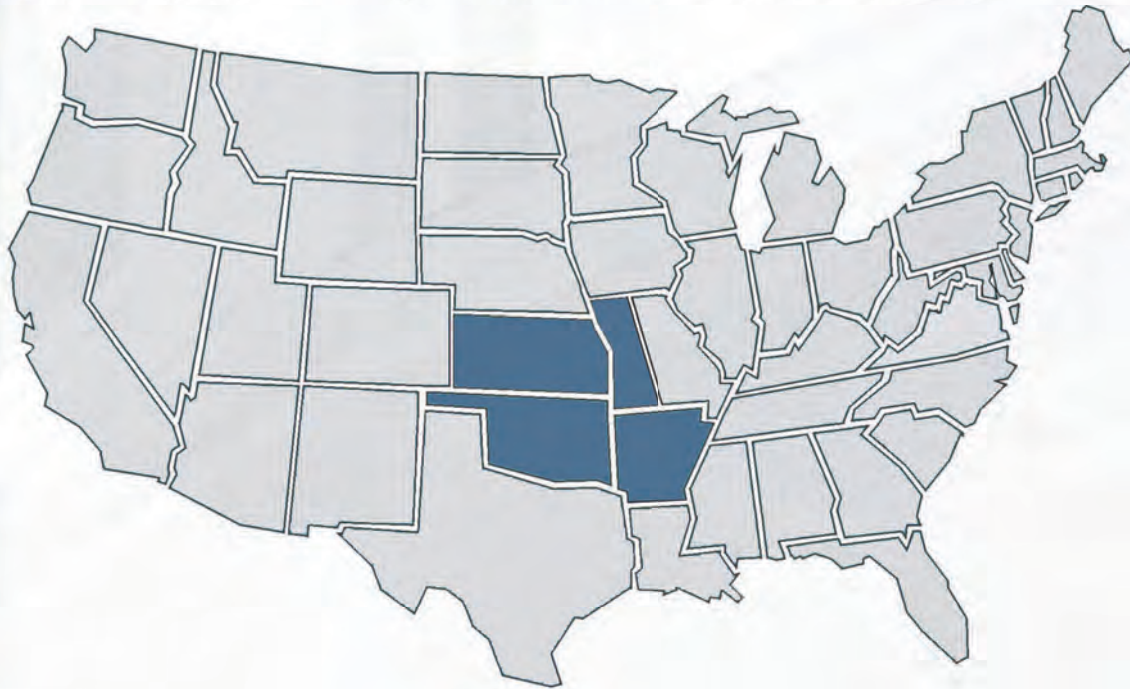

Customer Service: Ph 877-279-5096 • Fax 608-365-0493
www.acm-metals.com