

ROOFING *Accessories*



2018 Lodi Plant
PRODUCT CATALOG

www.acm-metals.com

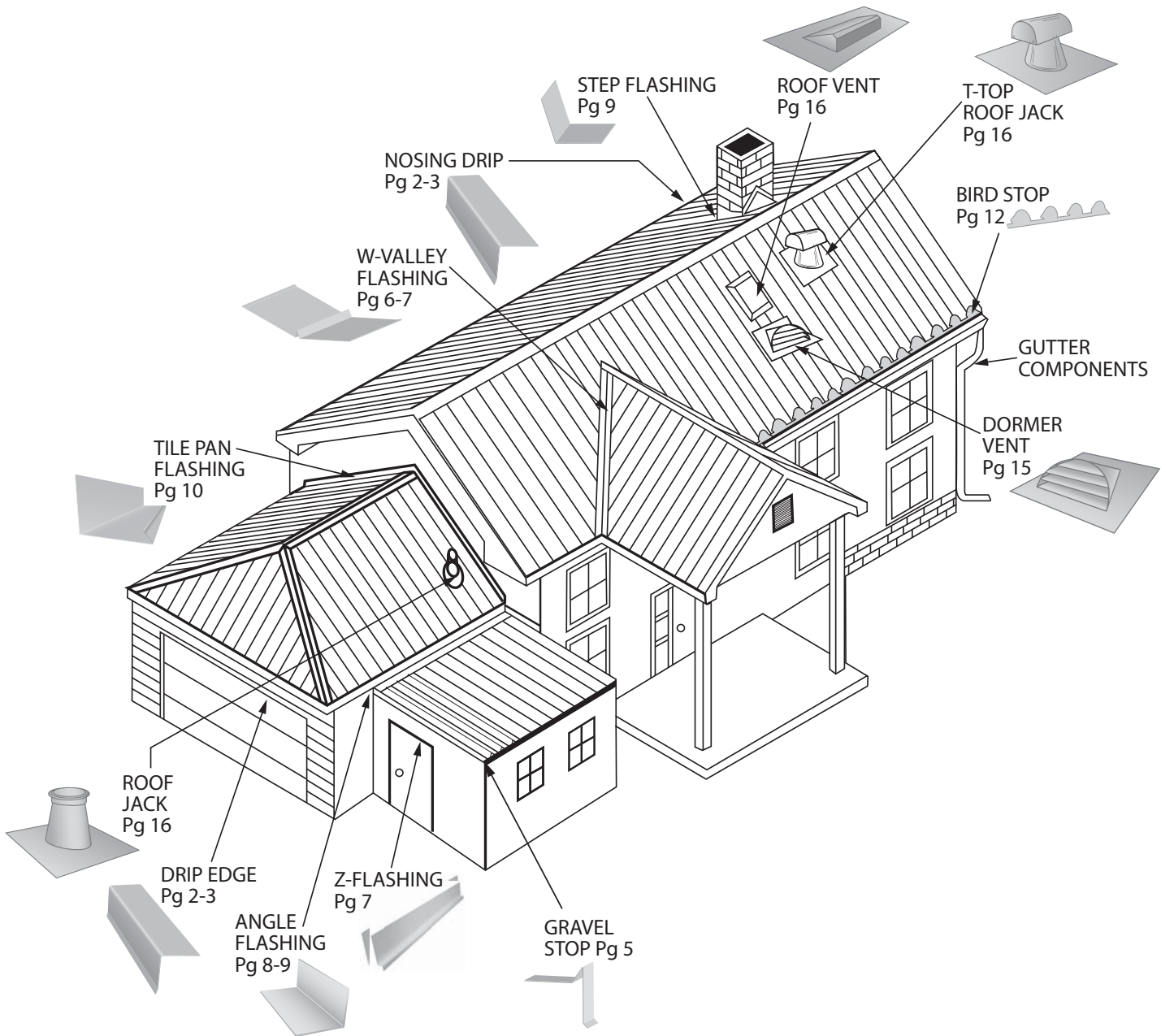

Table of Contents

Nosing Drip Edge	2-3	Tile Riser	11
Nosing Grip Edge	4	Scupper	11
Gravel Stop	5	Round Duct Pipe	11
Rain Diverter	6	Bird Stop	12
Peak Flashing	6	Capistrano/Espana.....	12
Roll Valley	6	Mission.....	12
W-Valley	6-7	Malibu.....	12
Roof to Wall Flashing	7	Villa.....	12
Z-Bar	7	Pipe Flashing	13-14
Flat Sheet	8	Plumber Flashing	14-15
Flat Shingle	8	Storm Collar	15
Angle Flashing	8-9	Sub Flashing	15
Pre-Bent Step Flashing	9	Dormer Vent	15
Counter Flashing	9	Eyebrow Vent	16
Reglet Flashing	10	Fan Jack	16
Saddle Stock	10	T-Top	16
Tile Pan Flashing	10	Parapet / Coping Cap	16
		Ventilation Products	17-18

All Norandex™ products are painted with Sherwin-Williams® Polykote 3000 paint system.



SHERWIN-WILLIAMS.

We reserve the right to change the content of product offerings at any time. Please consult the online catalog at www.acm-metals.com for the most update product offering.

Contact Information:

CUSTOMER SERVICE: 877-213-5962
www.acm-metals.com



Nosing Drip Edge

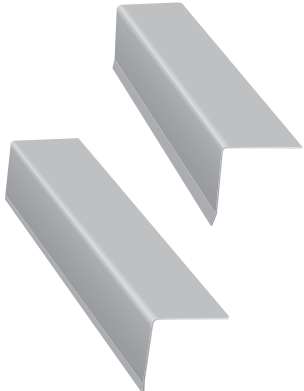

Part #	Description	Colors	Nom. Gauge/ Thickness	Pieces/ Bundle	Piece Length
AND9121 - -	Alum. 1 x 2 Nosing Drip 110°	RB, WH	0.019	10	10'
G3WE28 - -	Galv. Steel 3-Way Edging	BR, C3, WH	28 ga	10	10'
GND61515 - -	Galv. 1-1/2 x 1-1/2 Nosing Drip	BR, C3, WH	26 ga	10	10'
GND61515ML	Galv. 1-1/2 x 1-1/2 Nosing Drip	Mill	26 ga	10	10'
GND6153 - -	Galv. 1-1/2 x 3 Nosing Drip	BR, C3, WH	26 ga	10	10'
GND622 - -	Galv. 2 x 2 Nosing Drip	BR, C3, WH	26 ga	10	10'
GND622ML	Galv. 2 x 2 Nosing Drip	Mill	26 ga	10	10'
GND62211 - -	Galv. 2 x 2 Nosing Drip 110°	BR, C3, WH	26 ga	10	10'
GND62211ML	Galv. 2 x 2 Nosing Drip 110°	Mill	26 ga	10	10'
GND623 - -	Galv. 2 x 3 Nosing Drip	BR, C3, WH	26 ga	10	10'
GND623ML	Galv. 2 x 3 Nosing Drip	Mill	26 ga	10	10'
GND624 - -	Galv. 2 x 4 Nosing Drip	BR, C3, WH	26 ga	10	10'
GND624ML	Galv. 2 x 4 Nosing Drip	Mill	26 ga	10	10'
GND62411 - -	Galv. 2 x 4 Nosing Drip 110°	BR, C3, WH	26 ga	10	10'
GND62411ML	Galv. 2 x 4 Nosing Drip 110°	Mill	26 ga	10	10'
GND626 - -	Galv. 2 x 6 Nosing Drip	BR, C3, WH	26 ga	10	10'
GND626ML	Galv. 2 x 6 Nosing Drip	Mill	26 ga	10	10'
GND62611 - -	Galv. 2 x 6 Nosing Drip 110°	BR, C3, WH	26 ga	10	10'
GND62611ML	Galv. 2 x 6 Nosing Drip 110°	Mill	26 ga	10	10'
GND628 - -	Galv. 2 x 8 Nosing Drip	BR, C3, WH	26 ga	10	10'
GND628ML	Galv. 2 x 8 Nosing Drip	Mill	26 ga	10	10'
GND6287 - -	Galv. 2 x 8 Nosing Drip 75°	BR, C3, WH	26 ga	10	10'
GND6287ML	Galv. 2 x 8 Nosing Drip 75°	Mill	26 ga	10	10'
GND62811 - -	Galv. 2 x 8 Nosing Drip 110°	BR, C3, WH	26 ga	10	10'
GND633 - -	Galv. 3 x 3 Nosing Drip	BR, C3, WH	26 ga	10	10'
GND633ML	Galv. 3 x 3 Nosing Drip	Mill	26 ga	10	10'
GND63311 - -	Galv. 3 x 3 Nosing Drip 110°	BR, C3, WH	26 ga	10	10'
GND644 - -	Galv. 4 x 4 Nosing Drip	BR, C3, WH	26 ga	10	10'
GND644ML	Galv. 4 x 4 Nosing Drip	Mill	26 ga	10	10'
GND6452 - -	Galv. 4 x 5 Nosing Drip 5/12 Pitch	BR, C3, WH	26 ga	10	10'
GND812 - -	Galv. 1 x 2 Nosing Drip	BR, C3, WH	28 ga	10	10'
GND812ML	Galv. 1 x 2 Nosing Drip	Mill	28 ga	10	10'
GND81515 - -	Galv. 1-1/2 x 1-1/2 Nosing Drip	BR, C3, WH	28 ga	10	10'
GND81515ML	Galv. 1-1/2 x 1-1/2 Nosing Drip	Mill	28 ga	10	10'
GND8152 - -	Galv. 1-1/2 x 2 Nosing Drip	BR, C3, WH	28 ga	10	10'
GND8152ML	Galv. 1-1/2 x 2 Nosing Drip	Mill	28 ga	10	10'
GND822 - -	Galv. 2 x 2 Nosing Drip	BR, C3, WH	28 ga	10	10'
GND822ML	Galv. 2 x 2 Nosing Drip	Mill	28 ga	10	10'
GND823 - -	Galv. 2 x 3 Nosing Drip	BR, C3, WH	28 ga	10	10'
GND823ML	Galv. 2 x 3 Nosing Drip	Mill	28 ga	10	10'

GND622, GND822

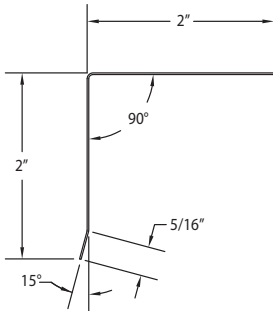

GND624

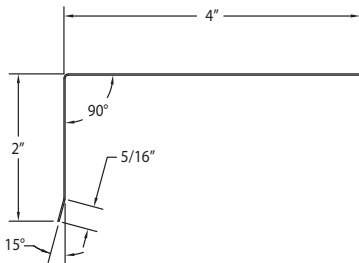

GND644

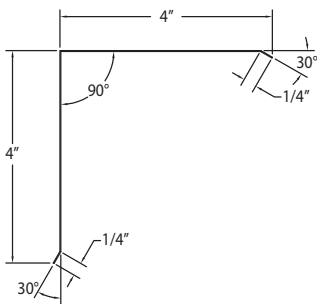

GND633

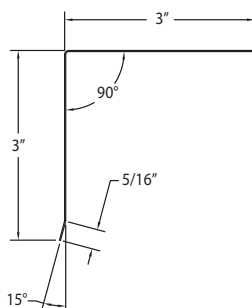

GND81515

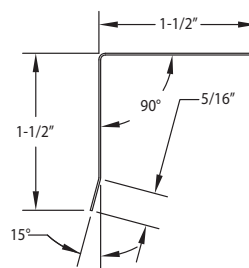

GND8152

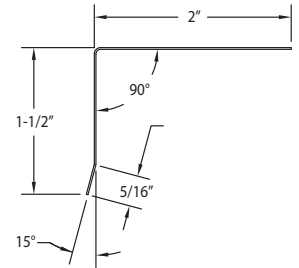

Roofing Accessories Colors:



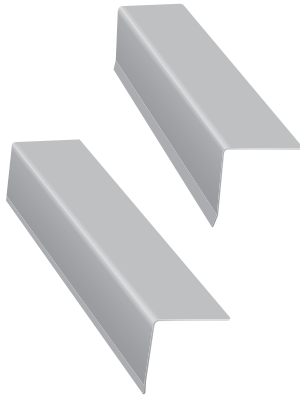
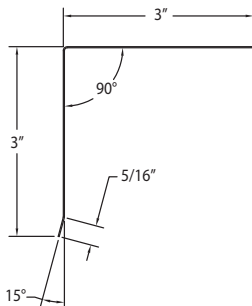
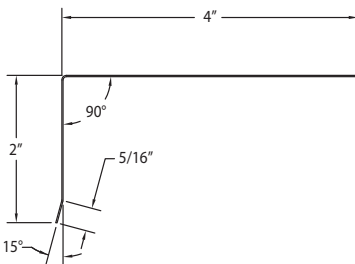

COLOR	CODE	COLOR	CODE	COLOR	CODE
BROWN	BR	CHARCOAL	C3	WHITE	WH

Nosing Drip Edge *cont.*

Part #	Description	Colors	Nom. Gauge/ Thickness	Pieces/ Box	Piece Length
GND824 - -	Galv. 2 x 4 Nosing Drip	BR, C3, WH	28 ga	10	10'
GND824ML	Galv. 2 x 4 Nosing Drip	Mill	28 ga	10	10'
GND8244 - -	Galv. 2 x 4 Nosing Drip 4/12 Pitch	BR, C3, WH	28 ga	10	10'
GND826 - -	Galv. 2 x 6 Nosing Drip	BR, C3, WH	28 ga	10	10'
GND833 - -	Galv. 3 x 3 Nosing Drip	BR, C3, WH	28 ga	10	10'
GND833ML	Galv. 3 x 3 Nosing Drip	Mill	28 ga	10	10'
LND612ML	Glum. 1 x 2 Nosing Drip	Mill	26 ga	10	10'
LND61515ML	Glum. 1-1/2 x 1-1/2 Nosing Drip	Mill	26 ga	10	10'
LND6153ML	Glum. 1-1/2 x 3 Nosing Drip	Mill	26 ga	10	10'
LND622ML	Glum. 2 x 2 Nosing Drip	Mill	26 ga	10	10'
LND624ML	Glum. 2 x 4 Nosing Drip	Mill	26 ga	10	10'
LND626ML	Glum. 2 x 6 Nosing Drip	Mill	26 ga	10	10'
LND62611ML	Glum. 2 x 6 Nosing Drip 110°	Mill	26 ga	10	10'
LND628ML	Glum. 2 x 8 Nosing Drip	Mill	26 ga	10	10'
LND62811ML	Glum. 2 x 8 Nosing Drip 110°	Mill	26 ga	10	10'
LND633ML	Glum. 3 x 3 Nosing Drip	Mill	26 ga	10	10'
LND644ML	Glum. 4 x 4 Nosing Drip	Mill	26 ga	10	10'
LND812ML	Glum. 1 x 2 Nosing Drip	Mill	28 ga	10	10'
LND81515ML	Glum. 1-1/2 x 1-1/2 Nosing Drip	Mill	28 ga	10	10'
LND8152ML	Glum. 1-1/2 x 2 Nosing Drip	Mill	28 ga	10	10'
LND822ML	Glum. 2 x 2 Nosing Drip	Mill	28 ga	10	10'
LND823ML	Glum. 2 x 4 Nosing Drip	Mill	28 ga	10	10'
LND824ML	Glum. 2 x 4 Nosing Drip	Mill	28 ga	10	10'
LND833ML	Glum. 3 x 3 Nosing Drip	Mill	28 ga	10	10'
LND844ML	Glum. 4 x 4 Nosing Drip	Mill	28 ga	10	10'
PND622	Bond. 2 x 2 Nosing Drip	Bond	26 ga	10	10'
PND624	Bond. 2 x 4 Nosing Drip	Bond	26 ga	10	10'
CND115	Copper 1 x 1-1/2 Nosing Drip	Copper	16 oz	Order by the pc.	10'
CND138	Copper 1-3/8 x 1-3/8 Nosing Drip	Copper	16 oz	Order by the pc.	10'
CND1515	Copper 1-1/2 x 1-1/2 Nosing Drip	Copper	16 oz	Order by the pc.	10'
CND152	Copper 1-1/2 x 2 Nosing Drip	Copper	16 oz	Order by the pc.	10'
CND22	Copper 2 x 2 Nosing Drip	Copper	16 oz	Order by the pc.	10'
CND225	Copper 2 x 2-1/2 Nosing Drip	Copper	16 oz	Order by the pc.	10'
CND24	Copper 2 x 4 Nosing Drip	Copper	16 oz	Order by the pc.	10'
CND258	Copper 2-5/8 x 2-5/8 Nosing Drip	Copper	16 oz	Order by the pc.	10'
CND33	Copper 3 x 3 Nosing Drip	Copper	16 oz	Order by the pc.	10'
CND44	Copper 4 x 4 Nosing Drip	Copper	16 oz	Order by the pc.	10'
CLDT13WH	TPO Clad 1 x 3 x 10 Drip Edge	WH	26 ga	1	10'
CLDT22WH	TPO Clad 2 x 2 x 10 Drip Edge	WH	26 ga	1	10'
CLDT24WH	TPO Clad 2 x 4 x 10 Drip Edge	WH	26 ga	1	10'
CLDT33WH	TPO Clad 3 x 3 x 10 Drip Edge	WH	26 ga	1	10'
CLDT34WH	TPO Clad 3 x 4 x 10 Drip Edge	WH	26 ga	1	10'
CLDT44WH	TPO Clad 4 x 4 x 10 Drip Edge	WH	26 ga	1	10'
CLDT73WH	TPO Clad 7 x 3 x 10 Drip Edge	WH	26 ga	1	10'
CLDTH24WH	TPO Clad 2 x 4 x 10 Drip Edge with Hem	WH	26 ga	1	10'
CLDTH33WH	TPO Clad 3 X 3 x 10 Drip Edge with 3/8" Hem	WH	26 ga	1	10'

GND833

GND824

Roofing Accessories Colors:

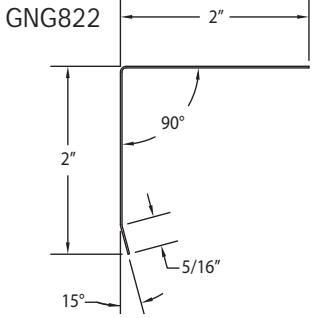
COLOR	CODE	COLOR	CODE	COLOR	CODE
BROWN	BR	CHARCOAL	C3	WHITE	WH

Nosing Grip Edge	Part #	Description	Colors	Nom. Gauge/ Thickness	Pieces/ Box	Piece Length
	GNG61515 - -	Galv. 1-1/2 x 1-1/2 Nosing Grip	BR, C3, WH	26 ga	10	10'
	GNG61515ML	Galv. 1-1/2 x 1-1/2 Nosing Grip	Mill	26 ga	10	10'
	GNG6152ML	Galv. 1-1/2 x 2 Nosing Grip	Mill	26 ga	10	10'
	GNG622 - -	Galv. 2 x 2 Nosing Grip	BR, C3, WH	26 ga	10	10'
	GNG622ML	Galv. 2 x 2 Nosing Grip	Mill	26 ga	10	10'
	GNG623 - -	Galv. 2 x 3 Nosing Grip	BR, C3, WH	26 ga	10	10'
	GNG623ML	Galv. 2 x 3 Nosing Grip	Mill	26 ga	10	10'
	GNG8115 - -	Galv. 1 x 1-1/2 Nosing Grip	BR, C3, WH	28 ga	10	10'
	GNG8115ML	Galv. 1 x 1-1/2 Nosing Grip	Mill	28 ga	10	10'
	GNG812 - -	Galv. 1 x 2 Nosing Grip	BR, C3, WH	28 ga	10	10'
GNG812ML	Galv. 1 x 2 Nosing Grip	Mill	28 ga	10	10'	
	GNG81515 - -	Galv. 1-1/2 x 1-1/2 Nosing Grip	BR, C3, WH	28 ga	10	10'
	GNG81515ML	Galv. 1-1/2 x 1-1/2 Nosing Grip	Mill	28 ga	10	10'
	GNG8152 - -	Galv. 1-1/2 x 2 Nosing Grip	BR, C3, WH	28 ga	10	10'
	GNG822 - -	Galv. 2 x 2 Nosing Grip	BR, C3, WH	28 ga	10	10'
	GNG822ML	Galv. 2 x 2 Nosing Grip	Mill	28 ga	10	10'
	GNG823 - -	Galv. 2 x 3 Nosing Grip	BR, C3, WH	28 ga	10	10'
	GNG823ML	Galv. 2 x 3 Nosing Grip	Mill	28 ga	10	10'
	GNG824 - -	Galv. 2 x 4 Nosing Grip	BR, C3, WH	28 ga	10	10'
	GNG824ML	Galv. 2 x 4 Nosing Grip	Mill	28 ga	10	10'
	GNG833 - -	Galv. 3 x 3 Nosing Grip	BR, C3, WH	28 ga	10	10'
GNG833ML	Galv. 3 x 3 Nosing Grip	Mill	28 ga	10	10'	
	GNG844ML	Galv. 4 x 4 Nosing Grip	Mill	28 ga	10	10'
	GNNG61515M	Galv. 1-1/2 x 1-1/2 Double Nose Grip	Mill	26 ga	10	10'
	GNNG61521M	Galv. 1-1/2 x 2 Double Nose Grip 110°	Mill	26 ga	10	10'
	GNNG622ML	Galv. 2 x 2 Double Nose Grip	Mill	26 ga	10	10'
	GNNG623ML	Galv. 2 x 3 Double Nose Grip	Mill	26 ga	10	10'
	LNG61515ML	Glum. 1-1/2 x 1-1/2 Nosing Grip	Mill	26 ga	10	10'
	LNG622ML	Glum. 2 x 2 Nosing Grip	Mill	26 ga	10	10'
	LNG624ML	Glum. 2 x 4 Nosing Grip	Mill	26 ga	10	10'
	LNG62411ML	Glum. 2 x 4 Nosing Grip 110°	Mill	26 ga	10	10'
	LNG812ML	Glum. 1 x 2 Nosing Grip	Mill	28 ga	10	10'
	LNG8152ML	Glum. 1-1/2 x 2 Nosing Grip	Mill	28 ga	10	10'
	LNG822ML	Glum. 2 x 2 Nosing Grip	Mill	28 ga	10	10'
	LNG823ML	Glum. 2 x 3 Nosing Grip	Mill	28 ga	10	10'
	LNG824ML	Glum. 2 x 4 Nosing Grip	Mill	28 ga	10	10'
	LNG833ML	Glum. 3 x 3 Nosing Grip	Mill	28 ga	10	10'
	LNG844ML	Glum. 4 x 4 Nosing Grip	Mill	28 ga	10	10'
	CNG22	Copper 2 x 2 Nosing Grip	Copper	16 oz	Order by the pc.	10'
	CLGT22	TPO Clad 2 x 2 x 10 Grip Edge	WH	26 ga	Order by the pc.	10'
	CLGT24	TPO Clad 2 x 4 x 10 Grip Edge	WH	26 ga	Order by the pc.	10'
	CLGT33	TPO Clad 3 x 3 x 10 Grip Edge	WH	26 ga	Order by the pc.	10'



Roofing Accessories Colors:

COLOR	CODE	COLOR	CODE	COLOR	CODE
BROWN	BR	CHARCOAL	C3	WHITE	WH

Gravel Stop

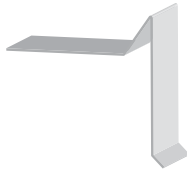

Part #	Description	Colors	Nom. Gauge/ Thickness	Pieces/ Box	Piece Length
GG624 - -	Galv. 2 x 4 Gravel Stop Drip	BR, C3, WH	26 ga	10	10'
GG624ML	Galv. 2 x 4 Gravel Stop Drip	Mill	26 ga	10	10'
GG633 - -	Galv. 3 x 3 Gravel Stop Drip	BR, C3, WH	26 ga	10	10'
GG633ML	Galv. 3 x 3 Gravel Stop Drip	Mill	26 ga	10	10'
GG644 - -	Galv. 4 x 4 Gravel Stop Drip	BR, C3, WH	26 ga	10	10'
GG644ML	Galv. 4 x 4 Gravel Stop Drip	Mill	26 ga	10	10'
GG822ML	Galv. 2 x 2 Gravel Stop Drip	Mill	28 ga	10	10'
GG824 - -	Galv. 2 x 4 Gravel Stop Drip	BR, C3, WH	28 ga	10	10'
GG824ML	Galv. 2 x 4 Gravel Stop Drip	Mill	28 ga	10	10'
GG833 - -	Galv. 3 x 3 Gravel Stop Drip	BR, C3, WH	28 ga	10	10'
GG833ML	Galv. 3 x 3 Gravel Stop Drip	Mill	28 ga	10	10'
GG844 - -	Galv. 4 x 4 Gravel Stop Drip	BR, C3, WH	28 ga	10	10'
GG844ML	Galv. 4 x 4 Gravel Stop Drip	Mill	28 ga	10	10'
GGSG822ML	Galv. 2 x 2 Gravel Stop Grip	Mill	28 ga	10	10'
GGSG82525M	Galv. 2-1/2 x 2-1/2 Gravel Stop Grip	Mill	28 ga	10	10'
GGSG824ML	Galv. 2 x 4 Gravel Stop Grip	Mill	28 ga	10	10'
GGSG833ML	Galv. 3 x 3 Gravel Stop Grip	Mill	28 ga	10	10'
GGSG844ML	Galv. 4 x 4 Gravel Stop Grip	Mill	28 ga	10	10'
GGSH622F - -	Galv. 2 x 2 Gravel Stop FHA 3/4 Rise	BR, C3, WH	26 ga	10	10'
GGSH622FML	Galv. 2 x 2 Gravel Stop FHA 3/4 Rise	Mill	26 ga	10	10'
GGSH633F - -	Galv. 3 x 3 Gravel Stop FHA 3/4 Rise	BR, C3, WH	26 ga	10	10'
GGSL622 - -	Galv. 2 x 2 Gravel Stop Drip Low	BR, C3, WH	26 ga	10	10'
GGSL622ML	Galv. 2 x 2 Gravel Stop Drip Low	Mill	26 ga	10	10'
GGSL624 - -	Galv. 2 x 4 Gravel Stop Drip Low	BR, C3, WH	26 ga	10	10'
GGSL633 - -	Galv. 3 x 3 Gravel Stop Drip Low	BR, C3, WH	26 ga	10	10'
GGSL633ML	Galv. 3 x 3 Gravel Stop Drip Low	ML	26 ga	10	10'
GGSL824 - -	Galv. 2 x 4 Gravel Stop Drip Low	BR, C3, WH	28 ga	10	10'
GGSL824ML	Galv. 2 x 4 Gravel Stop Drip Low	Mill	28 ga	10	10'
GGSL833 - -	Galv. 3 x 3 Gravel Stop Drip Low	BR, C3, WH	28 ga	10	10'
GGSL833ML	Galv. 3 x 3 Gravel Stop Drip Low	Mill	28 ga	10	10'
LGS824ML	Glum. 2 x 4 Gravel Stop Drip	Mill	28 ga	10	10'
LGS833ML	Glum. 3 x 3 Gravel Stop Drip	Mill	28 ga	10	10'
LGS844ML	Glum. 4 x 4 Gravel Stop Drip	Mill	28 ga	10	10'
LGSL624ML	Glum. 2 x 4 Gravel Stop Drip Low	Mill	26 ga	10	10'
LGSL633ML	Glum. 3 x 3 Gravel Stop Drip Low	Mill	26 ga	10	10'
LGSL644ML	Glum. 4 x 4 Gravel Stop Drip Low	Mill	26 ga	10	10'
LGSL823ML	Glum. 2 x 3 Gravel Stop Drip Low	Mill	28 ga	10	10'
LGSL824ML	Glum. 2 x 4 Gravel Stop Drip Low	Mill	28 ga	10	10'
LGSL833ML	Glum. 3 x 3 Gravel Stop Drip Low	Mill	28 ga	10	10'
LGSL834ML	Glum. 3 x 4 Gravel Stop Drip Low	Mill	28 ga	10	10'
LGSL844ML	Glum. 4 x 4 Gravel Stop Drip Low	Mill	28 ga	10	10'
PGS624	Bond. 2 x 4 Gravel Drip	Bond	26 ga	10	10'
PGS633	Bond. 3 x 3 Gravel Drip	Bond	26 ga	10	10'
PGS634	Bond. 3 x 4 Gravel Drip	Bond	26 ga	10	10'
PGSL624	Bond. 2 x 4 Gravel Drip Low	Bond	26 ga	10	10'
PGSL633	Bond. 3 x 3 Gravel Drip Low	Bond	26 ga	10	10'
PGSL634	Bond. 3 x 4 Gravel Drip Low	Bond	26 ga	10	10'
CLGS2254WH	TPO Clad 2 x 1/4 x 4 Gravel Stop	WH	26 ga	1	10'
CLGS3253WH	TPO Clad 3 x 1/4 x 3 Gravel Stop	WH	26 ga	1	10'

***NOTE:** Rise available in 1/8, 1/4, & 1/2

Roofing Accessories Colors:

COLOR	CODE	COLOR	CODE	COLOR	CODE
BROWN	BR	CHARCOAL	C3	WHITE	WH

Rain Diverter	Part #	Description	Colors	Nom. Gauge/ Thickness	Pieces/ Box	Piece Length
	GRD62135ML	Galv. 2 x 13-1/2 x 1/2 Rain Diverter	Mill	26 ga	Order by the Pc.	10'



Peak Flashing	Part #	Description	Colors	Nom. Gauge/ Thickness	Pieces/ Box
	GPH6644ML	Galv. 6 x 4 Dual Hem Peak Flashing 4/12	Mill	26 ga	25

Roll Valley	Part #	Description	Colors	Nom. Gauge/ Thickness	Pieces/ Box	Piece Length
	ARV11085ML	Alum. 8" x 50' Roll Valley	Mill	0.011	1	50'
	ARV11145ML	Alum. 14" x 50' Roll Valley	Mill	0.011	1	50'
	ARV20ML	Alum. 20" x 50' Roll Valley	Mill	0.011	1	50'
	GRV26438ML	Galv. 48" x 30' Roll Valley	Mill	26 ga	1	30'
	GRV26085ML	Galv. 8" x 50' Roll Valley	Mill	26 ga	1	50'
	GRV26145ML	Galv. 14" x 50' Roll Valley	Mill	26 ga	1	50'
	GRV26205ML	Galv. 20" x 50' Roll Valley	Mill	26 ga	1	50'
	GRV31365ML	Galv. 36" x 50' Roll Valley Econo.	Mill	31 ga	1	50'
	GRV31065ML	Galv. 6" x 50' Roll Valley Econo.	Mill	31 ga	1	50'
	GRV31085ML	Galv. 8" x 50' Roll Valley Econo.	Mill	31 ga	1	50'
	GRV31205ML	Galv. 20" x 50' Roll Valley Econo.	Mill	31 ga	1	50'
	GRV14ML	Galv. 14" x 50' Roll Valley Econo.	Mill	32 ga	1	50'

W-Valley	Part #	Description	Colors	Nom. Gauge/ Thickness	Pieces/ Box	Piece Length
	GTV3C624ML	Galv. 24" Tile Valley 3 Crown	Mill	26 ga	10	10'
	GTV5C624 - -	Galv. 24" W-Valley Tile 5 Crown	BR, C3, WH	26 ga	10	10'
	GTV5C624ML	Galv. 24" W-Valley Tile 5 Crown	Mill	26 ga	10	10'
	GTV624ML	Galv. 24" Tile Valley	Mill	26 ga	10	10'
	GWWH2618 - -	Galv. 18" W-Valley Hem	BR, C3, WH	26 ga	10	10'
	GWWH2618ML	Galv. 18" W-Valley Hem	Mill	26 ga	10	10'
	GWWH2624 - -	Galv. 24" W-Valley Hem	BR, C3, WH	26 ga	10	10'
	GWWH2624ML	Galv. 24" W-Valley Hem	Mill	26 ga	10	10'
	GWWH2818 - -	Galv. 18" W-Valley Hem	BR, C3, WH	28 ga	10	10'
	GWWH2818ML	Galv. 18" W-Valley Hem	Mill	28 ga	10	10'
	GWWH2824 - -	Galv. 24" W-Valley Hem	BR, C3, WH	28 ga	10	10'
	GWWH2824ML	Galv. 24" W-Valley Hem	Mill	28 ga	10	10'

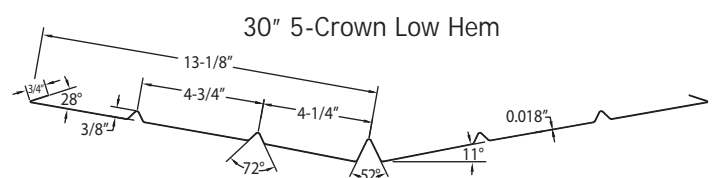
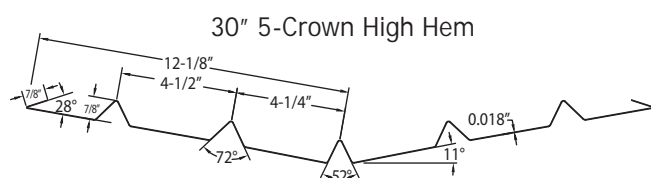
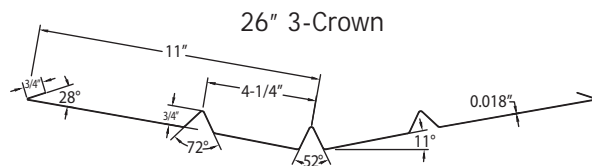
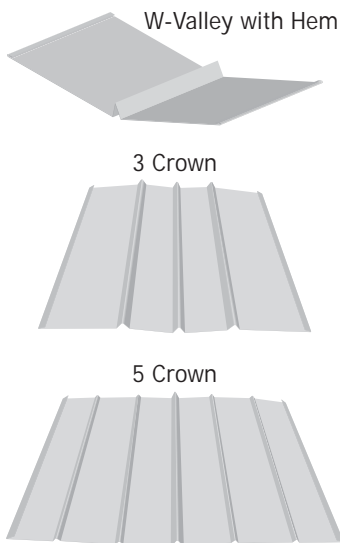

Roofing Accessories Colors:

COLOR	CODE	COLOR	CODE	COLOR	CODE
BROWN	BR	CHARCOAL	C3	WHITE	WH

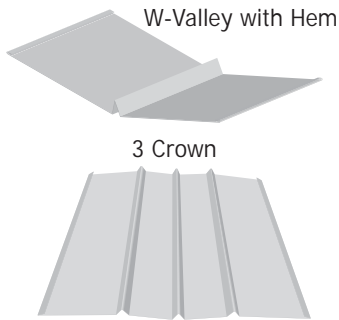
W-Valley cont.

Part #	Description	Colors	Nom. Gauge/ Thickness	Pieces/ Box	Piece Length
LTV3C624ML	Glum. 24" 3 Crown Tile Valley	Mill	26 ga	10	10'
LTV5C630ML	Glum. 30" 5 Crown Tile Valley	Mill	26 ga	10	10'
LTV5CL630M	Glum. 30" 5 Crown Tile Valley Low	Mill	26 ga	10	10'
LWV3CH624M	Glum. 24" 3 Crown W-Valley Hem	Mill	26 ga	10	10'
LWVH2624ML	Glum. 24" W-Valley Hem	Mill	26 ga	10	10'
LWVH2818ML	Glum. 18" W-Valley Hem	Mill	28 ga	10	10'
LWVH2824ML	Glum. 24" W-Valley Hem	Mill	28 ga	10	10'
LWVT2624ML	Glum. 24" W-Valley Tile	Mill	26 ga	10	10'
CWVH18	Copper 18" W-Valley Hem	Copper	20 oz	Order by the pc.	10'
CWVH24	Copper 24" W-Valley Hem	Copper	20 oz	Order by the pc.	10'

Roof to Wall

Part #	Description	Colors	Nom. Gauge/ Thickness	Pieces/ Box	Piece Length
GRTW6235ML	Galv. 2 x 3-1/2 Roof to Wall 105°	Mill	26 ga	10	10'
GRTW6241ML	Galv. 2 x 4 Roof to Wall 110°	Mill	26 ga	10	10'
GRTW6261ML	Galv. 2 x 6 Roof to Wall 110°	Mill	26 ga	10	10'
GRTW6444ML	Galv. 4 x 4 Roof to Wall 4/12	Mill	26 ga	10	10'
GRTW646ML	Galv. 4 x 6 Roof to Wall 110°	Mill	26 ga	10	10'
GRTW6681ML	Galv. 6 x 8 Roof to Wall 110°	Mill	26 ga	10	10'
LRTW6241ML	Glum. 2 x 4 Roof to Wall 110°	Mill	26 ga	10	10'
LRTW6261ML	Glum. 2 x 6 Roof to Wall 110°	Mill	26 ga	10	10'
LRTW6351ML	Glum. 3 x 5 Roof to Wall 110°	Mill	26 ga	10	10'
LRTW6441ML	Glum. 4 x 4 Roof to Wall 110°	Mill	26 ga	10	10'
LRTW6451ML	Glum. 4 x 5 Roof to Wall 110°	Mill	26 ga	10	10'
LRTW6461ML	Glum. 4 x 6 Roof to Wall 110°	Mill	26 ga	10	10'
LRTW6561ML	Glum. 5 x 6 Roof to Wall 110°	Mill	26 ga	10	10'
LRTW8241ML	Glum. 2 x 4 Roof to Wall 110°	Mill	28 ga	10	10'
LRTW8261ML	Glum. 2 x 6 Roof to Wall 110°	Mill	28 ga	10	10'
LRTW8461ML	Glum. 4 x 6 Roof to Wall 110°	Mill	28 ga	10	10'
PRTW6681	Bond. 6 x 8 Roof to Wall 110°	Bond	26 ga	10	10'
CRTW26	Copper 2 x 6 Roof to Wall	Copper	16 oz	Order by the pc.	10'
CRTW46	Copper 4 x 6 Roof to Wall	Copper	16 oz	Order by the pc.	10'
CRTW66	Copper 6 x 6 Roof to Wall	Copper	16 oz	Order by the pc.	10'

Z-Bar

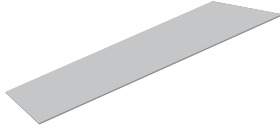

Part #	Description	Colors	Nom. Gauge/ Thickness	Pieces/ Box	Piece Length
GZB6203805	Galv. 2 x 3/8 x 1/2 Z-Bar	Mill	26 ga	10	10'
GZB6200505	Galv. 2 x 1/2 x 1/2 Z-Bar	Mill	26 ga	10	10'
GZB6205805	Galv. 2 x 5/8 x 1/2 Z-Bar	Mill	26 ga	10	10'
GZB6201020	Galv. 2 x 1 x 2 Z-Bar	Mill	26 ga	10	10'
GZB6201030	Galv. 2 x 1 x 3 Z-Bar	Mill	26 ga	10	10'
GZB64051	Galv. 2 x 1-1/4 x 1/2 100° Z-Bar	Mill	26 ga	10	10'
GZB6215515	Galv. 2 x 1-1/2 x 1/2 15° Z-Bar	Mill	26 ga	10	10'
GZB6220510	Galv. 2 x 2 x 1/2 100° Z-Bar	Mill	26 ga	10	10'
GZB6220515	Galv. 2 x 2 x 1/2 15° Z-Bar	Mill	26 ga	10	10'
GZB6224058	Galv. 2 x 2-1/4 x 1/2 80° Z-Bar	Mill	26 ga	10	10'
GZB6301515	Galv. 3 x 1-1/2 x 1-1/2 Z-Bar	Mill	26 ga	10	10'
GZB6302405	Galv. 3 x 2-1/4 x 1/2 Z-Bar	Mill	26 ga	10	10'
LZB6201020	Glum. 2 x 1 x 2 Z-Bar	Mill	26 ga	10	10'
LZB6201030	Glum. 2 x 1 x 3 Z-Bar	Mill	26 ga	10	10'
LZB8201030	Glum. 2 x 1 x 3 Z-Bar	Mill	28 ga	10	10'

Flat Sheet



Part #	Description	Colors	Nom. Gauge/ Thickness	Lbs/Full Pallet	Lbs/Half Pallet	Piece Length
GFS16410ML	Galv. 4 x 10 Flat Sheet	Mill	16 ga	4,000 Lbs.	n/a	10'
GFS18410ML	Galv. 4 x 10 Flat Sheet	Mill	18 ga	4,000 Lbs.	n/a	10'
GFS22410ML	Galv. 4 x 10 Flat Sheet	Mill	22 ga	4,000 Lbs.	2,000 Lbs.	10'
GFS24310ML	Galv. 3 x 10 Flat Sheet	Mill	24 ga	4,000 Lbs.	2,000 Lbs.	10'
GFS24410ML	Galv. 4 x 10 Flat Sheet	Mill	24 ga	4,000 Lbs.	2,000 Lbs.	10'
GFS26310ML	Galv. 3 x 10 Flat Sheet	Mill	26 ga	4,000 Lbs.	2,000 Lbs.	10'
GFS26410ML	Galv. 4 x 10 Flat Sheet	Mill	26 ga	4,000 Lbs.	2,000 Lbs.	10'
GFS83510ML	Galv. 5 x 10 Flat Sheet	Mill	28 ga	4,000 Lbs.	2,000 Lbs.	10'
BFS24410	Bond. 4 x 10 Flat Sheet	Bond	24 ga	4,000 Lbs.	2,000 Lbs.	10'
BFS26410	Bond. 4 x 10 Flat Sheet	Bond	26 ga	4,000 Lbs.	2,000 Lbs.	10'
CLFS410WH	TPO Clad 4 x 10 Flat Sheet	WH	26 ga	-	-	-

Flat Shingle



Part #	Description	Colors	Nom. Gauge/ Thickness	Pieces/ Bundle	Piece Length
GSF658 - -	Galv. 5 x 8 Flat Shingles	BR, C3, WH	26 ga	100	8"
GSF668 - -	Galv. 6 x 8 Flat Shingles	BR, C3, WH	26 ga	100	8"
GSF66850 - -	Galv. 6 x 8 Flat Shingles	BR, C3, WH	26 ga	50	8"
GSF6812 - -	Galv. 8 x 12 Flat Shingles	BR, C3, WH	26 ga	50	12"
GSF857ML	Galv. 5 x 7 Flat Shingles	Mill	28 ga	100	7"
GSF85750BR	Galv. 5 x 7 Flat Shingles	BR	28 ga	50	7"
GSF85750ML	Galv. 5 x 7 Flat Shingles	Mill	28 ga	50	7"
GSF868 - -	Galv. 6 x 8 Flat Shingles	BR, C3, WH	28 ga	100	8"
GSF86850 - -	Galv. 6 x 8 Flat Shingles	BR, C3, WH	28 ga	50	8"
GSF86850ML	Galv. 6 x 8 Flat Shingles	Mill	28 ga	50	8"
GSF8812 - -	Galv. 8 x 12 Flat Shingles	BR, C3, WH	28 ga	50	12"
GSF8812ML	Galv. 8 x 12 Flat Shingles	Mill	28 ga	50	12"
LSF657ML	Glum. 5 x 7 Flat Shingles	Mill	26 ga	100	7"
LSF66850ML	Glum. 6 x 8 Flat Shingles	Mill	26 ga	50	8"
LSF668ML	Glum. 6 x 8 Flat Shingles	Mill	26 ga	100	8"
LSF6812ML	Glum. 8 x 12 Flat Shingles	Mill	26 ga	50	12"
LSF86850ML	Glum. 6 x 8 Flat Shingles	Mill	28 ga	50	8"
LSF868ML	Glum. 6 x 8 Flat Shingles	Mill	28 ga	100	8"
LSF8812ML	Glum. 8 x 12 Flat Shingles	Mill	28 ga	50	12"

Angle Flashing

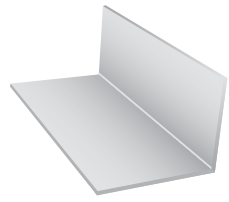

Part #	Description	Colors	Nom. Gauge/ Thickness	Pieces/ Box	Piece Length
AAF9121 - -	Alum. 1 x 2 Angle Flashing 110°	MB, RB	0.019	10	10'
GAF6115ML	Galv. 1 x 1-1/2 Angle Flashing	Mill	26 ga	10	10'
GAF6124ML	Galv. 1 x 2 4/12 Angle Flashing	Mill	26 ga	10	10'
GAF61515ML	Galv. 1-1/2 x 1-1/2 Angle Flashing	Mill	26 ga	10	10'
GAF6214ML	Galv. 1 x 14 Angle Flashing	Mill	26 ga	10	10'
GAF6215ML	Galv. 1 x 15 Angle Flashing	Mill	26 ga	10	10'
GAF623ML	Galv. 2 x 3 Angle Flashing	Mill	26 ga	10	10'
GAF635ML	Galv. 3 x 5 Angle Flashing	Mill	26 ga	10	10'
GAF646ML	Galv. 4 x 6 Angle Flashing	Mill	26 ga	10	10'
GAF6410ML	Galv. 4 x 10 Angle Flashing	Mill	26 ga	10	10'
GAF666RB	Galv. 6 x 6 Angle Flashing	RB	26 ga	10	10'
GAF666ML	Galv. 6 x 6 Angle Flashing	Mill	26 ga	10	10'
GTUF6355ML	Galv. 3-1/2 x 1/2 x 1/2 x 1/2 Tucker Flashing	Mill	26 ga	10	10'
GTUF8355ML	Galv. 3-1/2 x 1/2 x 1/2 x 1/2 Tucker Flashing	Mill	28 ga	10	10'
LAF624ML	Glum. 2 x 4 Angle Flashing	Mill	26 ga	10	10'
LAF633ML	Glum. 3 x 3 Angle Flashing	Mill	26 ga	10	10'
LAF644ML	Glum. 4 x 4 Angle Flashing	Mill	26 ga	10	10'
LAF646ML	Glum. 4 x 6 Angle Flashing	Mill	26 ga	10	10'

Roofing Accessories Colors:

COLOR	CODE	COLOR	CODE	COLOR	CODE	COLOR	CODE
BROWN	BR	CHARCOAL	C3	ROYAL BROWN	RB	WHITE	WH

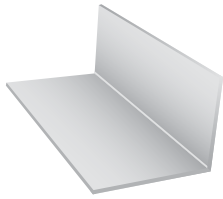
Angle Flashing *cont.*

Part #	Description	Colors	Nom. Gauge/ Thickness	Pieces/ Box	Piece Length
LAF666ML	Glum. 6 x 6 Angle Flashing	Mill	26 ga	10	10'
LAF824ML	Glum. 2 x 4 Angle Flashing	Mill	28 ga	10	10'
LAF844ML	Glum. 4 x 4 Angle Flashing	Mill	28 ga	10	10'
LAF846ML	Glum. 4 x 6 Angle Flashing	Mill	28 ga	10	10'
LAF866ML	Glum. 6 x 6 Angle Flashing	Mill	28 ga	10	10'
CLAFT66WH	TPO Clad 6 x 6 Angle Flashing	WH	24 ga	1	6'
CLAFT612WH	TPO Clad 6 x 12 Angle Flashing	WH	24 ga	1	12'

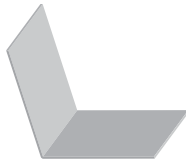
**Pre-Bent
Step Flashing**

Part #	Description	Colors	Nom. Gauge/ Thickness	Pieces/ Box	Piece Length
GPSF6338ML	Galv. 3 x 3 x 8 Step Shingles	Mill	26 ga	50	8"
GPSF6357 - -	Galv. 3 x 5 x 7 Step Shingles	BR, WH	26 ga	50	7"
GPSF6357ML	Galv. 3 x 5 x 7 Step Shingles	Mill	26 ga	50	7"
GPSF6358 - -	Galv. 3 x 5 x 8 Step Shingles	BR, C3	26 ga	50	8"
GPSF6358ML	Galv. 3 x 5 x 8 Step Shingles	Mill	26 ga	50	8"
GPSF6448ML	Galv. 4 x 4 x 8 Step Shingles	Mill	26 ga	50	8"
GPSF64412M	Galv. 4 x 4 x 12 Step Shingles	Mill	26 ga	50	12"
GPSF64585B	Galv. 4 x 5 x 8 Step Shingles	BR	26 ga	50	8"
GPSF6458ML	Galv. 4 x 5 x 8 Step Shingles	Mill	26 ga	50	8"
GPSF64614M	Galv. 4 x 6 x 14 Step Shingles	Mill	26 ga	50	14"
GPSF6464BR	Galv. 4 x 6 x 14 Step Shingles	BR	26 ga	50	14"
GPSF6558BR	Galv. 5 x 5 x 8 Step Shingles	BR	26 ga	50	8"
GPSF6558ML	Galv. 5 x 5 x 8 Step Shingles	Mill	26 ga	50	8"
GPSF6668 - -	Galv. 6 x 6 x 8 Step Shingles	BR, C3	26 ga	50	8"
GPSF6668ML	Galv. 6 x 6 x 8 Step Shingles	Mill	26 ga	50	8"
GPSF6746BR	Galv. 7 x 4 x 6 Step Shingles	BR	26 ga	50	6"
GPSF8357ML	Galv. 3 x 5 x 7 Step Shingles	Mill	28 ga	50	7"
GPSF8358C3	Galv. 3 x 5 x 8 Step Shingles	C3	28 ga	50	8"
GPSF8358ML	Galv. 3 x 5 x 8 Step Shingles	Mill	28 ga	50	8"
GPSF84614M	Galv. 4 x 6 x 14 Step Shingles	Mill	28 ga	50	14"
GPSF8558ML	Galv. 5 x 5 x 8 Step Shingles	Mill	28 ga	50	8"
GPSF8555ML	Galv. 5 x 5 x 10 Step Shingles	Mill	28 ga	50	10"
GPSF8668ML	Galv. 6 x 6 x 8 Step Shingles	Mill	28 ga	50	8"
CPSF357	Copper 3 x 5 x 7 Step Shingles	Copper	16 oz	Order by the pc.	7"
CPSF88	Copper 8 x 8 Step Shingles	Copper	10 oz	Order by the pc.	8"

Counter Flashing



Part #	Description	Colors	Nom. Gauge/ Thickness	Pieces/ Box	Piece Length
GCF264ML	Galv. 4" Counter Flashing	Mill	26 ga	10	10'
GCF2655ML	Galv. 5" Counter Flashing	Mill	26 ga	10	10'
GCF266ML	Galv. 6" Counter Flashing	Mill	26 ga	10	10'
GCF268ML	Galv. 8" Counter Flashing	Mill	26 ga	10	10'
GCF2853ML	Galv. 1/2 x 3 Counter Flashing	Mill	28 ga	10	10'
LCF264ML	Glum. 4" Counter Flashing	Mill	26 ga	10	10'
LCF2653ML	Glum. 1/2 x 3 Counter Flashing	Mill	26 ga	10	10'
LCF2655ML	Glum. 1/2 x 5 Counter Flashing	Mill	26 ga	10	10'
LCF266ML	Glum. 6" Counter Flashing	Mill	26 ga	10	10'
LCF2853ML	Glum. 1/2 x 3 Counter Flashing	Mill	28 ga	10	10'
LCF2855ML	Glum. 1/2 x 5 Counter Flashing	Mill	28 ga	10	10'
CCF55	Copper 1/2 x 5 Counter Flashing	Copper	16 oz	Order by the pc.	10'

Roofing Accessories Colors:

COLOR	CODE	COLOR	CODE	COLOR	CODE
BROWN	BR	CHARCOAL	C3	WHITE	WH

Reglet Flashing

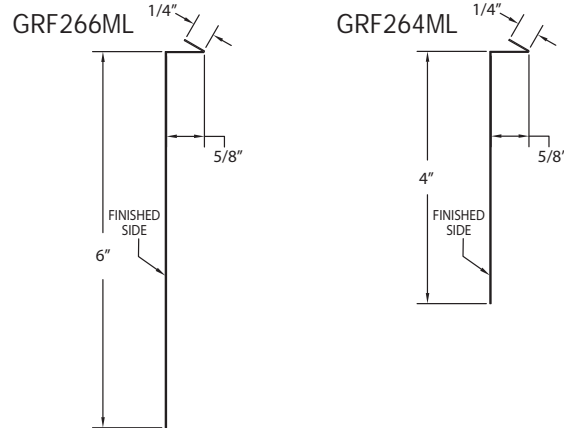
Part #	Description	Colors	Nom. Gauge/ Thickness	Pieces/ Box	Boxes/ Pallet	Pieces/ Pallet	Piece Length
GRF2653ML	Galv. 1/2 x 3 Reglet Flashing	Mill	26 ga	10	25	250	10'
GRF264ML	Galv. 1/2 x 4 Reglet Flashing	Mill	26 ga	10	25	250	10'
GRF2655ML	Galv. 1/2 x 5 Reglet Flashing	Mill	26 ga	10	25	250	10'
GRF266ML	Galv. 1/2 x 6 Reglet Flashing	Mill	26 ga	10	25	250	10'
GRF268ML	Galv. 1/2 x 8 Reglet Flashing	Mill	26 ga	10	25	250	10'
GRF2853ML	Galv. 1/2 x 3 Reglet Flashing	Mill	28 ga	10	25	250	10'
GRF2855ML	Galv. 1/2 x 5 Reglet Flashing	Mill	28 ga	10	25	250	10'



Saddle Stock

Part #	Description	Colors	Nom. Gauge/ Thickness	Pieces/ Box	Piece Length
GSA6414ML	Galv. 4 x 14 Saddle Stock 90°	Mill	26 ga	10	14"
GSA6614ML	Galv. 6 x 14 Saddle Stock 90°	Mill	26 ga	10	14"
LSA6414ML	Glum. 4 x 14 Saddle Stock 90°	Mill	26 ga	10	14"
LSA66149ML	Glum. 6 x 14 Saddle Stock 90°	Mill	26 ga	10	14"
LSA84149ML	Glum. 4 x 14 Saddle Stock 90°	Mill	28 ga	10	14"
LSA86149ML	Glum. 6 x 14 Saddle Stock 90°	Mill	28 ga	10	14"
CSA414	Copper 4 x 14 Saddle Stock 90°	Copper	16 oz	Order by the pc.	14"

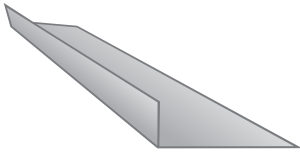

Tile Pan

Part #	Description	Colors	Nom. Gauge/ Thickness	Pieces/ Box	Piece Length
GTP6461ML	Galv. 4 x 6 x 1 Tile Pan	Mill	26 ga	10	10'
GTP64611ML	Galv. 4 x 6 x 1 Tile Pan 110°	Mill	26 ga	10	10'
GTP6471ML	Galv. 4 x 7 x 1 Tile Pan	Mill	26 ga	10	10'
GTP64711ML	Galv. 4 x 7 x 1 Tile Pan 110°	Mill	26 ga	10	10'
GTP6681ML	Galv. 6 x 8 x 1 Tile Pan	Mill	26 ga	10	10'
GTPR6881ML	Galv. 8 x 8 x 1 Ribbed Tile Pan	Mill	26 ga	10	10'
LTP63545ML	Glum. 3-1/2 x 4 x 1/2 Tile Pan	Mill	26 ga	10	10'
LTP63565ML	Glum. 3-1/2 x 6 x 1/2 Tile Pan	Mill	26 ga	10	10'
LTP63585ML	Glum. 3-1/2 x 8 x 1/2 Tile Pan	Mill	26 ga	10	10'
LTP6461ML	Glum. 4 x 6 x 1 Tile Pan	Mill	26 ga	10	10'
LTP6471ML	Glum. 4 x 7 x 1 Tile Pan	Mill	26 ga	10	10'
LTP83545ML	Glum. 3-1/2 x 4 x 1/2 Tile Pan	Mill	28 ga	10	10'
LTP83565ML	Glum. 3-1/2 x 6 x 1/2 Tile Pan	Mill	28 ga	10	10'
PTPR26681	Bond. 6 x 8 x 1 Ribbed Tile Pan	Bond	26 ga	10	10'

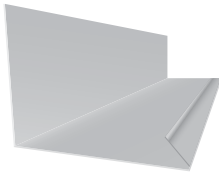

Tile Riser

Part #	Description	Colors	Nom. Gauge/ Thickness	Pieces/ Box	Piece Length
GTRFL78 - -	Galv. Tile Riser Flat 7/8	BK, BR, WH	28 ga	1	10'
GTRFLV - -	Galv. Tile Riser Flat Vent	BK, BR, C3, WH	28 ga	1	10'
GTRFL - -	Galv. 1-1/2 x 2-1/4 Eave Riser	BK, BR, C3, WH	28 ga	1	10'

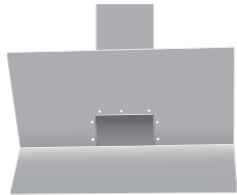
Scupper

Part #	Description	Colors	Nom. Gauge/ Thickness	Pieces/ Box
GSCC23ML	Galv. 2 x 3 Scupper Center	Mill	26 ga	1
GSCC33ML	Galv. 3 x 3 Scupper Center	Mill	26 ga	1
GSCC34ML	Galv. 3 x 4 Scupper Center	Mill	26 ga	1
GSCC46ML	Galv. 4 x 6 Scupper Center	Mill	26 ga	1
GSCC55ML	Galv. 5 x 5 Scupper Center	Mill	26 ga	1
GSCL23ML	Galv. 2 x 3 Scupper Left Corner	Mill	26 ga	1
GSCL34ML	Galv. 3 x 4 Scupper Left Corner	Mill	26 ga	1
GSCL46ML	Galv. 4 x 6 Scupper Left Corner	Mill	26 ga	1
GSCR23ML	Galv. 2 x 3 Scupper Right Corner	Mill	26 ga	1
GSCR34ML	Galv. 3 x 4 Scupper Right Corner	Mill	26 ga	1
GSCR46ML	Galv. 4 x 6 Scupper Right Corner	Mill	26 ga	1

Roofing Accessories Colors:

COLOR	CODE	COLOR	CODE	COLOR	CODE	COLOR	CODE
BLACK	BK	BROWN	BR	CHARCOAL	C3	WHITE	WH

Bird Stop	Part #	Description	Colors	Nom. Gauge/ Thickness	Pieces/ Box	Piece Length
	GBSES - -	Bird Stop Capistrano/Espana (So. Cal./Boral, AZ/Eagle)	BK, BR, C3, RD	28 ga	1	10'
	GBSMS - -	Bird Stop Mission (No. Cal./AZ, Boral)	BK, C3, RD	28 ga	1	10'
	GBSMU - -	Bird Stop Malibu (Eagle)	BK, BR, C3, RD	28 ga	1	10'
	GBSV9 - -	Bird Stop Villa (Boral)	BK, BR, C3, RD	28 ga	1	10'

BIRD STOP DIMENSIONS



GBSES
Capistrano/Espana
(So. Cal./Boral, AZ/Eagle)
this profile fits both

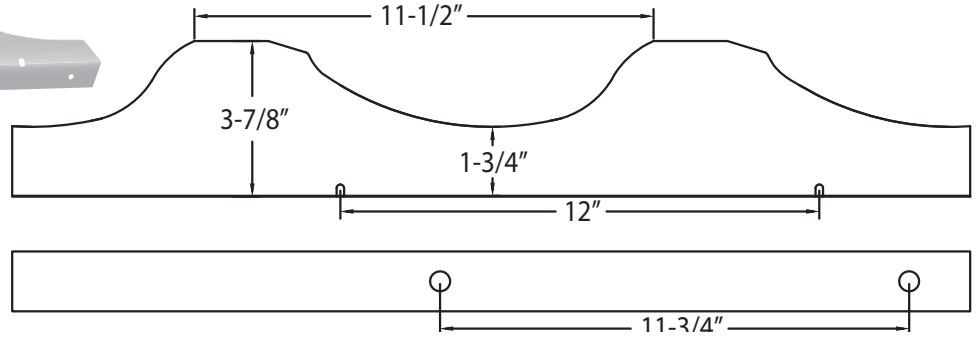

GBSMS
Mission
(No. Cal./AZ, Boral)

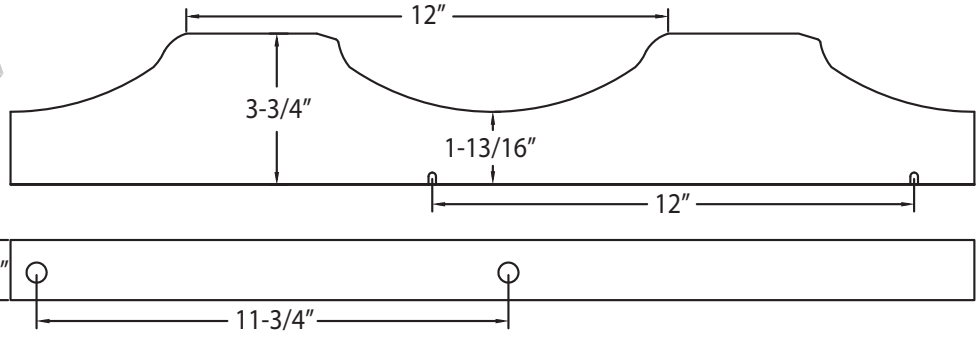

GBSMU
Malibu
(Eagle)

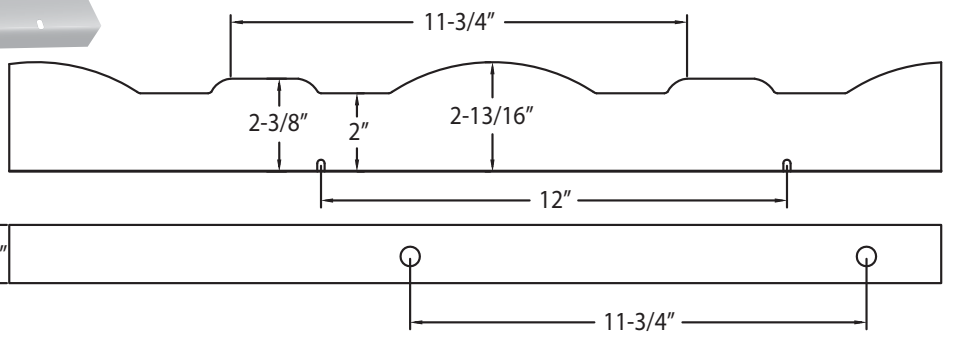

GBSV9
Villa
(Boral)

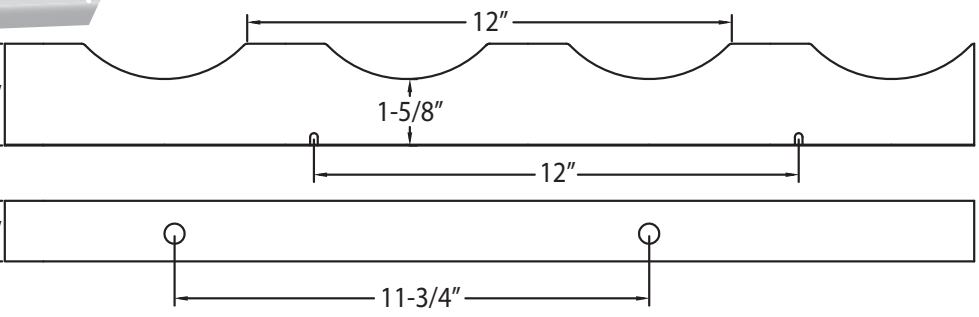

Roofing Accessories Colors:

COLOR	CODE	COLOR	CODE	COLOR	CODE	COLOR	CODE
BLACK	BK	BROWN	BR	CHARCOAL	C3	RED	RD

ROUND PIPE FLASHINGS

Outside diameter of pipe determines the opening of the flashing

3" PIPE



4" PIPE

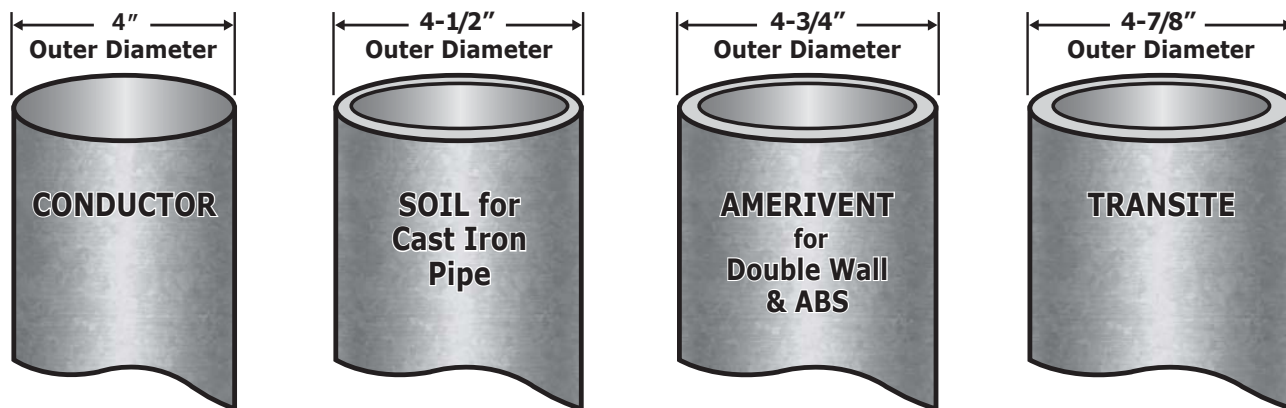

Pipe Flashing

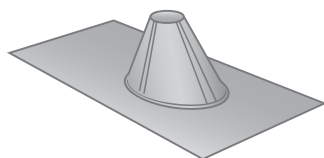

GPF2ML

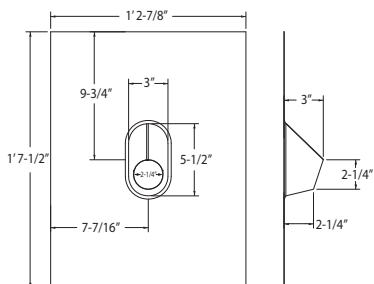

Part #	Description	Colors	Nom. Gauge/ Thickness	Pieces/ Bundle
GPF12ML	Galv. 1/2" Pipe Flashing Regular BASE	Mill	26 ga	25
GPF34ML	Galv. 3/4" Pipe Flashing	Mill	26 ga	25
GPF1ML	Galv. 1" Pipe Flashing	Mill	26 ga	25
GPF15ML	Galv. 1-1/2" Pipe Flashing	Mill	26 ga	25
GPF2ML	Galv. 2" Pipe Flashing	Mill	26 ga	25
GPF3DML	Galv. 3" Pipe Flashing Double Wall	Mill	26 ga	25
GPF3ML	Galv. 3" Pipe Flashing	Mill	26 ga	25
GPF4DML	Galv. 4" Pipe Flashing Double Wall	Mill	26 ga	15
GPF4ML	Galv. 4" Pipe Flashing	Mill	26 ga	25
GPF5ML	Galv. 5" Pipe Flashing	Mill	26 ga	12
GPF6ML	Galv. 6" Pipe Flashing	Mill	26 ga	12
GPF7ML	Galv. 7" Pipe Flashing	Mill	26 ga	1
GPF8ML	Galv. 8" Pipe Flashing	Mill	26 ga	1
GPF12ML	Galv. 1/2" Pipe Flashing FHA	Mill	26 ga	25
GPF34ML	Galv. 3/4" Pipe Flashing FHA	Mill	26 ga	25
GPF1ML	Galv. 1" Pipe Flashing FHA	Mill	26 ga	25
GPF15ML	Galv. 1-1/2" Pipe Flashing FHA	Mill	26 ga	25

Pipe Flashing *cont.*

Part #	Description	Colors	Nom. Gauge/ Thickness	Pieces/ Bundle
GPPF2ML	Galv. 2" Pipe Flashing FHA	Mill	26 ga	25
GPPF3ML	Galv. 3" Pipe Flashing FHA	Mill	26 ga	25
GPPF4ML	Galv. 4" Pipe Flashing FHA	Mill	26 ga	25
GPPF5ML	Galv. 5" Pipe Flashing FHA	Mill	26 ga	12
GPPF6ML	Galv. 6" Pipe Flashing FHA	Mill	26 ga	12
GPPF7ML	Galv. 7" Pipe Flashing FHA	Mill	26 ga	1
GPPF8ML	Galv. 8" Pipe Flashing FHA	Mill	26 ga	1
GPPF10ML	Galv. 10" Pipe Flashing FHA	Mill	26 ga	1
GPPFS3ML	Galv. 3" Pipe Flashing FHA Soil	Mill	26 ga	25
GPPFS4ML	Galv. 4" Pipe Flashing FHA Soil	Mill	26 ga	25
GPPFS5ML	Galv. 5" Pipe Flashing FHA Soil	Mill	26 ga	12
GPPFS6ML	Galv. 6" Pipe Flashing FHA Soil	Mill	26 ga	12
GPPF3DML	Galv. 3" Pipe Flashing Double Wall FHA	Mill	26 ga	25
GPPF4DML	Galv. 4" Pipe Flashing Double Wall FHA	Mill	26 ga	1
GPPFD6ML	Galv. 6" Pipe Flashing Double Wall FHA	Mill	26 ga	1
GPPFO4ML	Galv. 4" Oval Pipe Flashing FHA	Mill	26 ga	25

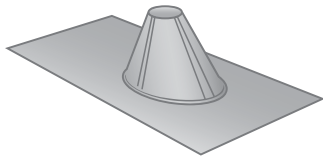

GPPF4ML

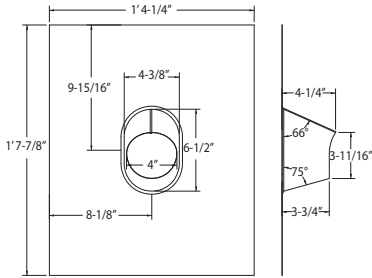

Plumber Flashing

Part #	Description	Colors	Nom. Gauge/ Thickness	Pieces/ Box
ADPRF12ML	Alum. 1/2" Plumbers Roof Flashing Aids.	Mill	0.019	20
ADPRF34ML	Alum. 3/4" Plumbers Roof Flashing Aids.	Mill	0.019	20
ADPRF1ML	Alum. 1" Plumbers Roof Flashing Aids.	Mill	0.019	20
ADPRF15ML	Alum. 1-1/2" Plumbers Roof Flashing Aids.	Mill	0.019	20
ADPRF2ML	Alum. 2" Plumbers Roof Flashing DS	Mill	0.019	20
ADPRF3ML	Alum. 3" Plumbers Roof Flashing Aids.	Mill	0.019	25
ADPRF4ML	Alum. 4" Plumbers Roof Flashing Aids.	Mill	0.019	20
ADPRF5ML	Alum. 5" Plumbers Roof Flashing Aids.	Mill	0.019	10
ADPRF6ML	Alum. 6" Plumbers Roof Flashing Aids.	Mill	0.019	10
ADPRF7ML	Alum. 7" Plumbers Roof Flashing DS	Mill	0.019	10
ADPRF8ML	Alum. 8" Plumbers Roof Flashing DS	Mill	0.019	10
ADPRF3DML	Alum. 3" Pipe Flashing Double Wall, Aids.	Mill	0.019	25
ADPRF4DML	Alum. 4" Pipe Flashing Double Wall, Aids.	Mill	0.019	25
ADPRFS3ML	Alum. 3" Plumbers Roof Flashing Soil, Aids.	Mill	0.019	25
ADPRFS4ML	Alum. 4" Plumbers Roof Flashing Soil, Aids.	Mill	0.019	25
ADPRFO4ML	Alum. 4" Plumbers Roof Flashing Oval Aids.	Mill	0.019	10
GPRF12ML	Galv. 1/2" Plumbers Roof Flashing	Mill	26 ga	25
GPRF34ML	Galv. 3/4" Plumbers Roof Flashing	Mill	26 ga	25
GPRF1ML	Galv. 1" Plumbers Roof Flashing	Mill	26 ga	25
GPRF15ML	Galv. 1-1/2" Plumbers Roof Flashing	Mill	26 ga	25
GPRF2ML	Galv. 2" Plumbers Roof Flashing	Mill	26 ga	25
GPRF3ML	Galv. 3" Plumbers Roof Flashing	Mill	26 ga	12
GPRF4ML	Galv. 4" Plumbers Roof Flashing	Mill	26 ga	12
GPRFS12ML	Galv. 1/2" Plumbers Roof Flashing Shingle	Mill	26 ga	25
GPRFS34ML	Galv. 3/4" Plumbers Roof Flashing Shingle	Mill	26 ga	25
GPRFS1ML	Galv. 1" Plumbers Roof Flashing Shingle	Mill	26 ga	25
GPRFS15ML	Galv. 1-1/2" Plumbers Roof Flashing Shingle	Mill	26 ga	25
GPRFS2ML	Galv. 2" Plumbers Roof Flashing Shingle	Mill	26 ga	25
GPRFS3ML	Galv. 3" Plumbers Roof Flashing Shingle	Mill	26 ga	12
GPRFS4ML	Galv. 4" Plumbers Roof Flashing Shingle	Mill	26 ga	12
GPRFSK34ML	Galv. 3/4" Plumbers Roof Flashing Shake	Mill	26 ga	25
GPRFSK1ML	Galv. 1" Plumbers Roof Flashing Shake	Mill	26 ga	25
GPRFSK15ML	Galv. 1-1/2" Plumbers Roof Flashing Shake	Mill	26 ga	25
GPRFSK2ML	Galv. 2" Plumbers Roof Flashing Shake	Mill	26 ga	25
GPRFSK3ML	Galv. 3" Plumbers Roof Flashing Shake	Mill	26 ga	12

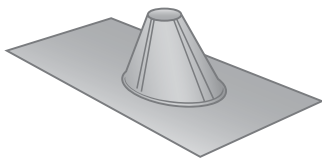

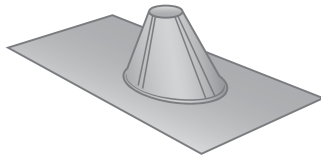
Plumber Flashing cont.

Part #	Description	Colors	Nom. Gauge/ Thickness	Pieces/ Box
GPRFSK4ML	Galv. 4" Plumbers Roof Flashing Shake	Mill	26 ga	12
GPRFSK5ML	Galv. 5" Plumbers Roof Flashing Shake	Mill	26 ga	1
GPRFSK6ML	Galv. 6" Plumbers Roof Flashing Shake	Mill	26 ga	1
GPRFSK7ML	Galv. 7" Plumbers Roof Flashing Shake	Mill	26 ga	1
GPRFSK8ML	Galv. 8" Plumbers Roof Flashing Shake	Mill	26 ga	1
GPRFSK10ML	Galv. 10" Plumbers Roof Flashing Shake	Mill	26 ga	1
LPRF34ML	Glum. 3/4" Plumbers Roof Flashing	Mill	26 ga	25
LPRF1ML	Glum. 1" Plumbers Roof Flashing	Mill	26 ga	25
LPRF15ML	Glum. 1-1/2" Plumbers Roof Flashing	Mill	26 ga	25
LPRF2ML	Glum. 2" Plumbers Roof Flashing	Mill	26 ga	25
LPRF3ML	Glum. 3" Plumbers Roof Flashing	Mill	26 ga	12
LPRF4ML	Glum. 4" Plumbers Roof Flashing	Mill	26 ga	12
LPRFS15ML	Glum. 1-1/2" Plumbers Flashing Shingle	Mill	26 ga	25
LPRFS3ML	Glum. 3" Plumbers Roof Flashing Shingle	Mill	26 ga	12
LPRFS4ML	Glum. 4" Plumbers Roof Flashing Shingle	Mill	26 ga	12
LPRFSK12ML	Glum. 1/2" Plumbers Roof Flashing Shake	Mill	26 ga	25
LPRFSK1ML	Glum. 1" Plumbers Roof Flashing Shake	Mill	26 ga	25
LPRFSK15ML	Glum. 1-1/2" Plumbers Roof Flashing Shake	Mill	26 ga	25
LPRFSK2ML	Glum. 2" Plumbers Roof Flashing Shake	Mill	26 ga	25
LPRFSK3ML	Glum. 3" Plumbers Roof Flashing Shake	Mill	26 ga	12
LPRFSK4ML	Glum. 4" Plumbers Roof Flashing Shake	Mill	26 ga	12
CPRF15	Copper 1-1/2" Plumbers Roof Flashing	Copper	26 ga	25

Storm Collar

Part #	Description	Colors	Nom. Gauge/ Thickness	Pieces/ Box
GSTC3ML	Galv. 3" Storm Collar	Mill	26 ga	1
GSTC4ML	Galv. 4" Storm Collar	Mill	26 ga	1
GSTC5ML	Galv. 5" Storm Collar	Mill	26 ga	1
GSTC6ML	Galv. 6" Storm Collar	Mill	26 ga	1
GSTCA3ML	Galv. 3" Storm Collar Adj.	Mill	26 ga	1
GSTCA4ML	Galv. 4" Storm Collar Adj.	Mill	26 ga	1
GSTCA5ML	Galv. 5" Storm Collar Adj.	Mill	26 ga	1
GSTCA6ML	Galv. 6" Storm Collar Adj.	Mill	26 ga	1
GSTCA8ML	Galv. 8" Storm Collar Adj.	Mill	26 ga	1
GSTCO4ML	Galv. 4" Storm Collar Oval	Mill	26 ga	1

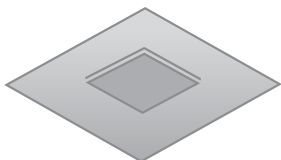
Sub Flashing

Part #	Description	Colors	Nom. Gauge/ Thickness	Pieces/ Box
GSBF78ML	Galv. 7 x 8 Sub Flashing	Mill	26 ga	1
GSBF1010ML	Galv. 10 x 10 Sub Flashing	Mill	26 ga	1
GSBF1414ML	Galv. 14 x 14 Sub Flashing	Mill	26 ga	1

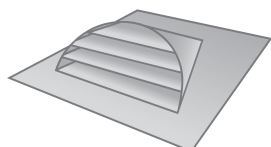
Dormer Vent

Part #	Description	Colors	Nom. Gauge/ Thickness	Pieces/ Box
ADV5918ML	Alum. 9 x 18 Shake Dormer Vent, 75 NFA sq. in.	Mill	25 ga	1
ADV51224ML	Alum. 12 x 24 Shake Dormer Vent, 100 NFA sq. in.	Mill	25 ga	1
LDVH918ML	Glum. 9 x 18 Half Round Dormer Vent, 75 NFA sq. in.	Mill	26 ga	1
LDVH1224ML	Glum. 12 x 24 Half Round Dormer Vent, 100 NFA sq. in.	Mill	26 ga	1
LDVHT918ML	Glum. 9 x 18 Half Round Dormer Vent w/Tile Hook, 75 NFA sq. in.	Mill	26 ga	1
LDVHT1224M	Glum. 12 x 24 Half Round Dormer Vent w/Tile Hook, 100 NFA sq. in.	Mill	26 ga	1

Eyebrow Vent

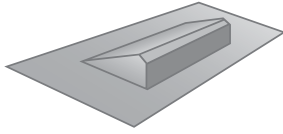

Part #	Description	Colors	Nom. Gauge/ Thickness	Pieces/ Box
GEVRML	Galv. 22 x 31 Eyebrow Vents Regular 37 NFA sq. in.	Mill	26 ga	24
GEVSML	Galv. 31 x 28 Eyebrow Vents Shake 37 NFA sq. in.	Mill	26 ga	24

Fan Jack

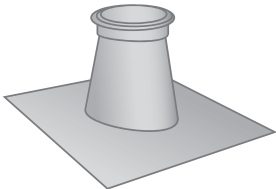

Part #	Description	Colors	Nom. Gauge/ Thickness	Pieces/ Box
GFNJ4ML	Galv. 4" Fan Jack Regular	Mill	26 ga	1
GFNJ6ML	Galv. 6" Fan Jack Regular	Mill	26 ga	1
GFNJ8ML	Galv. 8" Fan Jack Regular	Mill	26 ga	1
GFNJS6ML	Galv. 6" Fan Jack Shake	Mill	26 ga	1
GFNJS8ML	Galv. 8" Fan Jack Shake	Mill	26 ga	1
CFNJ4212	Copper 4" Fan Jack Regular, 2 Pc. 12/12		16 oz	Order by the pc.

T-Top

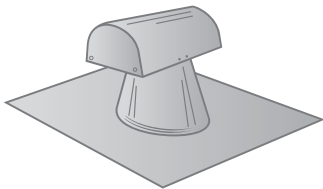

Part #	Description	Colors	Nom. Gauge/ Thickness	Pieces/ Box
ADTTRS4ML	Alum. 4" T-Tops DS Soil	Mill	0.025	25
ADTTR7ML	Alum. 7" T-Tops DS Cond.	Mill	0.025	25
GTTF4ML	Galv. 4" T-Tops Cond. FHA	Mill	26 ga	25
GTTF7ML	Galv. 7" T-Tops FHA	Mill	26 ga	25
GTTFS4ML	Galv. 4" T-Tops Soil FHA	Mill	26 ga	25
GTTR4ML	Galv. 4" T-Tops Regular	Mill	26 ga	25
GTTR7ML	Galv. 7" T-Tops Regular	Mill	26 ga	25
GTTRE4ML	Galv. 4" T-Tops Regular with Ends	Mill	26 ga	25
GTTRE7ML	Galv. 7" T-Tops Regular with Ends	Mill	26 ga	25
GTT4ML	Galv. 4" T-Tops Shake	Mill	26 ga	25
GTTST4ML	Galv. 4" T-Tops Shake with Tile	Mill	26 ga	25
GTTST7ML	Galv. 7" T-Tops Shake with Tile	Mill	26 ga	25
GTTSTE4ML	Galv. 4" T-Tops Shake Tile with Ends	Mill	26 ga	25
GTTSTE7ML	Galv. 7" T-Tops Shake Tile with Ends	Mill	26 ga	25
GTTSF6ML	Galv. 6" T-Tops Square FHA	Mill	26 ga	25
GTTSE4ML	Galv. 4" T-Tops Shake with Ends	Mill	26 ga	25
GTTSE7ML	Galv. 7" T-Tops Shake with Ends	Mill	26 ga	25
LTTR7ML	Glum. 7" T-Tops Regular	Mill	26 ga	25
LTTS7ML	Glum. 7" T-Tops Shake	Mill	26 ga	25
LTSE4ML	Glum. 4" T-Tops Shake with Ends	Mill	26 ga	25

GTTF411

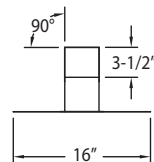
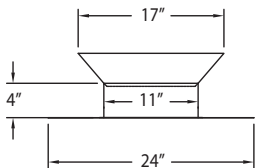
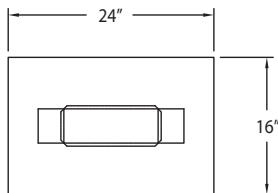

Parapet/Coping Cap

Part #	Description	Colors	Nom. Gauge/ Thickness	Pieces/ Box
GCCD6373ML	Galv. 3 x 7 x 3 Coping Cap	Mill	26 ga	1
GPCD6272WH	Galv. 2 x 7 x 2 Coping with Drip	WH	26 ga	1
GPCD6292WH	Galv. 2 x 9 x 2 Coping with Drip	WH	26 ga	1
GPCD6282WH	Galv. 2 x 8 x 2 Coping with Drip	WH	26 ga	1
GPCD6282ML	Galv. 2 x 8 x 2 Coping with Drip	Mill	26 ga	1
GPCD641012	Galv. 4 x 10 x 12 Coping with Drip	Mill	26 ga	1
LPD6262ML	Glum. 2 x 6 x 2 Parapet Coping with Drip	Mill	26 ga	10
LPD6282ML	Glum. 2 x 8 x 2 Parapet Coping with Drip	Mill	26 ga	10
CLCD2318WH	TPO Clad 2 x 3-1/8 x 2 Coping with Drip	WH	24 ga	1
CLCD2378WH	TPO Clad 2 x 3-7/8 x 2 Coping with Drip	WH	24 ga	1
CLCD2425WH	TPO Clad 2 x 4-1/4 x 2 Coping with Drip	WH	24 ga	1
CLC334ML	TPO Clad 3 x 3 x 4 Coping	Mill	24 ga	1

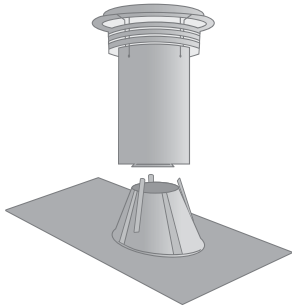
Ventilation Products

Part #	Description	Colors	Nom. Gauge/ Thickness	Pieces/ Box
ACCA3ML	Alum. 3" Code Cap Assembly Regular	Mill	N/A	6
ACCA4ML	Alum. 4" Code Cap Assembly Regular	Mill	N/A	6
ACCA5ML	Alum. 5" Code Cap Assembly Regular	Mill	N/A	6
ACCA6ML	Alum. 6" Code Cap Assembly Regular	Mill	N/A	6
ACCA7ML	Alum. 7" Code Cap Assembly Regular	Mill	N/A	6
ACCA8ML	Alum. 8" Code Cap Assembly Regular	Mill	0.250	6
ACCA10ML	Alum. 10" Code Cap Assembly Regular	Mill	0.250	6
ACCAOH4ML	Alum. 4" Code Cap Assy. Oval Horiz. Regular	Mill	N/A	6
ACCAOV4ML	Alum. 4" Code Cap Assy. Oval Vert. Regular	Mill	N/A	6
ACCAS3ML	Alum. 3" Code Cap Assembly Shake	Mill	N/A	6
ACCAS4ML	Alum. 4" Code Cap Assembly Shake	Mill	N/A	6
ACCAS5ML	Alum. 5" Code Cap Assembly Shake	Mill	N/A	6
ACCAS6ML	Alum. 6" Code Cap Assembly Shake	Mill	N/A	6
ACCAS7ML	Alum. 7" Code Cap Assembly Shake	Mill	N/A	6
ACCAS8ML	Alum. 8" Code Cap Assembly Shake	Mill	N/A	6
ACCASOH4ML	Alum. 4" Code Cap Assembly Shake Oval Horiz.	Mill	N/A	6
ACCASOV4ML	Alum. 4" Code Cap Assembly Shake Oval Vert.	Mill	N/A	6
ACCB3ML	Alum. 3" Code Cap Base Only Regular	Mill	N/A	1
ACCB4ML	Alum. 4" Code Cap Base Only Regular	Mill	N/A	1
ACCB5ML	Alum. 5" Code Cap Base Only Regular	Mill	N/A	1
ACCB6ML	Alum. 6" Code Cap Base Only Regular	Mill	N/A	1
ACCB7ML	Alum. 7" Code Cap Base Only Regular	Mill	N/A	1
ACCB8ML	Alum. 8" Code Cap Base Only Regular	Mill	N/A	1
ACCB10ML	Alum. 10" Code Cap Base Only Regular	Mill	N/A	1
ACCB12ML	Alum. 12" Code Cap Base Only Regular	Mill	N/A	1
ACCB0H4ML	Alum. 4" Code Cap Oval Horizontal Base Regular	Mill	N/A	1
ACCB0V4ML	Alum. 4" Code Cap Oval Vertical Base Regular	Mill	N/A	1
ACCBS3ML	Alum. 3" Code Cap Shake Base Only	Mill	N/A	1
ACCBS4ML	Alum. 4" Code Cap Shake Base Only	Mill	N/A	1
ACCBS5ML	Alum. 5" Code Cap Shake Base Only	Mill	N/A	1
ACCBS6ML	Alum. 6" Code Cap Shake Base Only	Mill	N/A	1
ACCBS6TML	Alum. 6" Code Cap Shake Base Only T	Mill	N/A	1
ACCBS7ML	Alum. 7" Code Cap Shake Base Only	Mill	N/A	1
ACCBS8ML	Alum. 8" Code Cap Shake Base Only	Mill	N/A	1
ACCBSOH4ML	Alum. 4" Oval Shake Base Only Horizontal	Mill	N/A	1
ACCBSOV4ML	Alum. 4" Oval Shake Base Only Vertical	Mill	N/A	1
ACCT3ML	Alum. 3" Code Cap Tops Only	Mill	N/A	1
ACCT4ML	Alum. 4" Code Cap Tops Only	Mill	N/A	1
ACCT5ML	Alum. 5" Code Cap Tops Only	Mill	N/A	1
ACCT6ML	Alum. 6" Code Cap Tops Only	Mill	N/A	1
ACCT7ML	Alum. 7" Code Cap Tops Only	Mill	N/A	1
ACCT8ML	Alum. 8" Code Cap Tops Only	Mill	N/A	1
ACCT10ML	Alum. 10" Code Cap Tops Only	Mill	N/A	1
ACCT12ML	Alum. 12" Code Cap Tops Only	Mill	N/A	1
ACCTO4ML	Alum. 4" Code Cap Oval Tops Only	Mill	N/A	1
ARVC3ML	Alum. 3" Round Vent Cap	Mill	N/A	20
ARVC4ML	Alum. 4" Round Vent Cap	Mill	N/A	20
ARVC5ML	Alum. 5" Round Vent Cap	Mill	N/A	20
ARVC6ML	Alum. 6" Round Vent Cap	Mill	N/A	20
ARVC7ML	Alum. 7" Round Vent Cap	Mill	N/A	20
ARVC8ML	Alum. 8" Round Vent Cap	Mill	N/A	20
AOVC4ML	Alum. 4" Oval Vent Cap	Mill	N/A	1

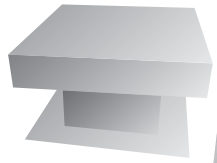
Ventilation Products *cont.*Gravity
Roof Vent

GGLR1424ML

Part #	Description	Colors	Nom. Gauge/ Thickness	Pieces/ Box
GGRV1414ML	Galv. 14 x 14 Gravity Roof Vent	Mill	26 ga	1
GGRV1818ML	Galv. 18 x 18 Gravity Roof Vent	Mill	26 ga	1
GGLR1424ML	Galv. 14 x 24 Gable Vent	Mill	28 ga	1
CCCA4	Copper 4" Code Cap Assembly Reg.	Copper	16 oz	Order by the pc.
CCCA6	Copper 6" Code Cap Assembly Reg.	Copper	16 oz	Order by the pc.
CCCAS6	Copper 6" Code Cap Assembly Shake	Copper	16 oz	Order by the pc.
CCCAB4	Copper 4" Code Cap Base Only	Copper	16 oz	Order by the pc.
CCCAB6	Copper 6" Code Cap Base Only	Copper	16 oz	Order by the pc.
CCCAT4	Copper 4" Code Cap Tops	Copper	16 oz	Order by the pc.
CCCAT6	Copper 6" Code Cap Tops	Copper	16 oz	Order by the pc.

ROOFING & SIDING Accessories



Many homes don't have the proper ventilation... Why?

- The same number of vents from the last roof are installed or repeating improper venting from a previous roof.
- Improper balance between the intake from the eaves and the outtake on the roof.
- Confusion regarding ventilation needed to properly vent the roof.

Homeowners are more likely to buy from a contractor who educates the homeowner. Proper ventilation is important because...

- The roof will last longer and be properly covered by manufacturer warranties.
- It lowers cooling costs.
- It reduces risk for mildew and mold.

More jobs and higher roofing sales come from doing the math!

1. Determine attic square footage:
Length _____ x Width _____ = Attic Square Footage _____.
2. Determine NFA (Net Free Area) requirements:
Attic Square Footage _____ ÷ 300 = NFA _____.
3. Convert square feet NFA to square inches:
NFA Square Feet _____ x 144 = NFA Square Inches _____.
4. Split between intake* (eaves) and outtake (roof):
NFA Square Inches _____ ÷ 2 = NFA Inches Needed _____.
5. Calculate number of vents needed:
NFA Inches Needed _____ ÷ Vent NFA _____ = # Amount of Vents _____.
6. Always round up number of vents to err on the side of caution so that roof material warranty is not voided.

**Don't forget to look at the ventilation in the eaves. You may have to make adjustments there as well!*

9 x 18 Shake or Half Round Dormer Vent

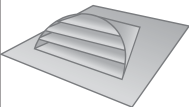
	Total Attic Sq. Ft.	Number of Vents	NFA Sq. In.
	0-1000	5	250
	1001-1500	7	350
	1501-2000	10	500
	2001-2500	12	600
	2501-3000	15	750

12 x 24 Shake or Half Round Vent

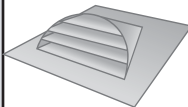
	Total Attic Sq. Ft.	Number of Vents	NFA Sq. In.
	0-1000	3	300
	1001-1500	4	400
	1501-2000	5	500
	2001-2500	6	600
	2501-3000	8	800

Eyebrow Vent

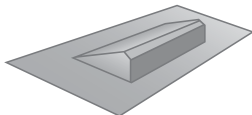
	Total Attic Sq. Ft.	Number of Vents	NFA Sq. In.
	0-1000	8	300
	1001-1500	11	400
	1501-2000	14	500
	2001-2500	16	600
	2501-3000	22	800



ROOFING & SIDING *Accessories*

Lodi Coverage Region

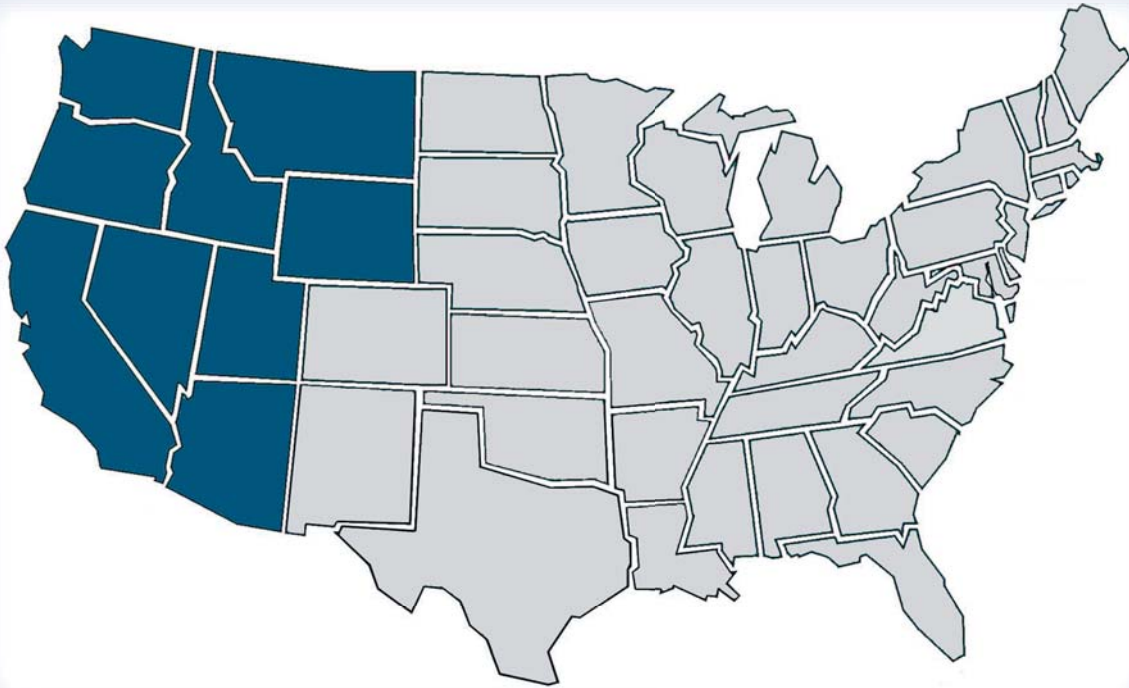

Customer Service: 877-213-5962
www.acm-metals.com