

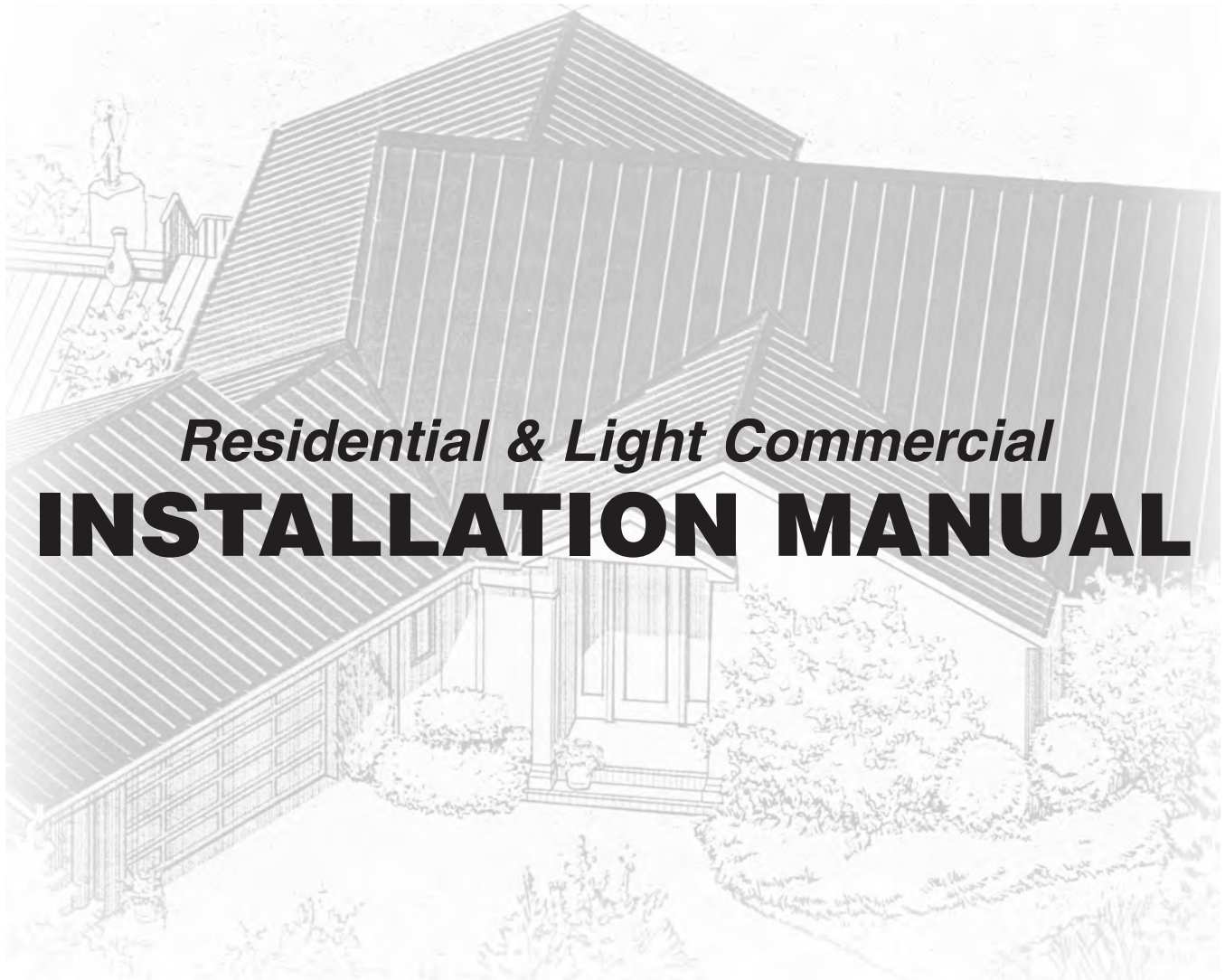

STAYLOC
Architectural Steel Roof System



Residential & Light Commercial
INSTALLATION MANUAL



StayLOC Architectural Steel Roof System INSTALLATION INSTRUCTIONS

Table of Contents

Architect/Engineer Information	4
Product Information	
General Description of StayLOC Panels	5
General Notes	6
Proper Handling	6
Proper Storage	7
Installation Tools and Equipment List.....	8
Installation Methods	9
Materials List (Fasteners, Flashing, and Sealants)	11
Trim Parts and Accessories	13
Designing Custom Trim Parts	16
Fastening	
StayLoc Panels	17
Fastener Selection Tables	18
General Fastening Guidelines	19
Pre-Installation Preparation - Sheathed Roofing Surfaces	19
General Panel Installation	21
Building Overview.....	23
Installation Details - Illustrative Drawings	24

Important note to the installer:

Carefully read and understand all installation instructions and study all of the installation details prior to starting installation of the building panels and associated materials. If a particular installation application associated with your installation is not addressed within these instructions or details, contact your product distributor for assistance. The warranty will be void for installation methods not approved by Manufacturer in writing. It is the installer's responsibility to ensure that the building materials are installed properly and as recommended by the Manufacturer.

DISCLAIMER: The Manufacturer is not responsible for any typographical errors and reserves the right to change specifications without notice.

StayLOC Architectural Steel Roof System INSTALLATION INSTRUCTIONS

Architect/Engineer Information

1. **Coverage:** StayLOC panels provide 16" of net coverage on the 1" & 1-1/2" rib height panels.
2. **Minimum roof slope:** StayLOC panels are hydrokinetic by design and, therefore, rely on gravity and slope to promote water shedding. A 3:12 slope or greater is recommended for all building panels.
3. **Material Specifications:** StayLOC panels meet all applicable ASTM A792 specifications for commercial galvalume Type B AZ55 (with clear coat).
4. **Finish:** Painted and clear coat finishes for StayLOC panels meet or exceed the ASTM B117 Salt Spray (1000 hrs.), and ASTM G23 Accelerated Weathering (2000 hrs.).
5. **Oil Canning:** Oil canning is not a cause for rejection. Oil canning is some amount of waviness found in the flat areas of the metal panels. Oil canning is a typical characteristic of light gauge cold-formed metal products, especially when there is a broad flat area. There are a number of factors that contribute to oil canning that are out of the control of the Manufacturer. Some of the factors are: poor alignment of the panel support system, over tightening of the panel fasteners, material stress (whether inherent in the panel or induced), thermal expansion and contraction of the material, mishandling of the panels, and incorrect product installation. Other factors to be aware of are: material gauge, width, length, and color.
6. **Decking Application:** To meet most code requirements, it is recommended that the panels be installed over 15/32" CD plywood min. when doing re-roof applications and 19/32" CD plywood for new construction. It is the building owners responsibility to see that the building is designed and constructed according to applicable structural and building code requirements.
7. **Weatherproof:** All panels require sealing/caulking at eave ends, ridge, and valley conditions. See drawing notes.
8. **Fastening:** For proper fastener application, refer to fastener charts, illustrations, and installation instructions. Take care to select the correct fastening method and schedule for your design requirements. It is recommended that extra fastening be done around the perimeter of the roof. A clip spacing of 12" on center should be used within 3'-0" of the roof edges.
9. **Accessories:** All accessories and perimeter trim in this manual are based on the nominal building panel dimensions and fabricated to the same material specifications.
10. **Foot Traffic:** Avoid any unnecessary foot traffic on StayLOC panels. If foot traffic is required, protect the roof panels by using some type of roof pad, temporary deck, or walkway between major ribs. Do not stand or apply weight directly on the major ribs.
11. **Hail and Impact Resistance:** StayLOC panels 26 gauge or thicker meet the requirements of UL 2218 Class 4 impact resistance.
12. **Wind Uplift:** StayLOC panels 24 gauge or thicker meet the specifications of UL 580 Class 90, construction No. 589, for wind uplift and UL 1897 uplift ratings of 225 psf for 1-1/2" high panels.
13. The application and detail drawings in this manual are strictly for illustration purposes and may not be applicable to all building designs or product installations. All projects should conform to applicable building codes for that particular area. It is recommended to follow all building regulations and standard industry practices. If there is any question as to information included in this manual, it should be reviewed by an architect or professional engineer.
14. This manual is designed to be utilized as a guide when installing an Architectural roofing system. It is the responsibility of the erector to ensure the safe installation of this product.
15. **Safety:** STUDY APPLICABLE OSHA AND OTHER SAFETY REQUIREMENTS BEFORE FOLLOWING THESE INSTRUCTIONS. The installation of metal roof systems is a dangerous procedure and should be supervised by trained knowledgeable erectors. USE EXTREME CARE WHILE INSTALLING ROOF PANELS. It is not possible for the Manufacturer to be aware of all the possible job site situations that could cause an unsafe condition to exist. The erector of the roof system is responsible for reading these instructions and determining the safest way to install the roof system. These instructions are provided only as a guide to show a knowledgeable, trained erector the correct parts placement one to another. If following any of the installation steps would endanger a worker, the erector should stop work and decide upon a corrective action. Provide required safety railing, netting, or safety lines for crew members working on the roof. Do not use the roof panels as a walking platform. The roof panels will not withstand the weight of a person standing at the edge of the panel.

StayLOC Architectural Steel Roof System INSTALLATION INSTRUCTIONS

Product Information

General Description for StayLOC panels:

	Architectural Building Panels	
Profile	StayLOC - 1" Rib Height	StayLOC - 1-1/2" Rib Height
Coverage Width	16"	16"
Minimum Slope	3:12	3:12
Panel Attachment	Clip	Clip
Panel Material	Galvalume Grade 50 Yield Strength Steel or Aluminum	
Gauge	(26 or 24 Ga) Stl. or .032" Alum.	(26 or 24 Ga) Stl. or .032" Alum.
Surface	Smooth, Ribbed, or Striated	
Finish	Siliconized Modified Polyester, Kynar 500, or Acrylic Galvalume	

StayLOC 1" Rib Height:



StayLOC 1-1/2" Rib Height:

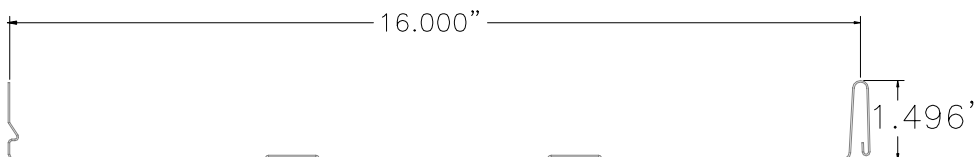

StayLOC Architectural Steel Roof System

INSTALLATION INSTRUCTIONS

General Notes

1. These installation instructions have been prepared to assist the installer with various recommended details and common obstacles encountered when installing metal roofing systems.
2. The roofing panels are not identical or symmetrical, so it is important that the panels are properly orientated in the same direction during installation. Although panels may be erected from either direction, the panels cannot be reversed or turned end for end once installation has started. It is recommended that when installing the panels, the overlapping seams between panels be oriented away from prevailing wind and rain directions.
3. Care should be taken during installation to prevent spreading of the panel width. Spreading of the panel width could detract from its appearance and may lead to problems with installation of the trim accessories.
4. Each panel can be manufactured with stiffening ribs in the flat area of the panel to minimize oil canning. However, due to the inherent characteristics of the commercially available metals, some oil canning should be anticipated. Any oil canning experienced will not be cause for rejection.
5. To prevent damage from excessive foot traffic, it is recommended that the foot traffic on the panels be limited. However, should some foot traffic be necessary, boards or plywood strips should be placed over the panels. Excessive foot traffic may lead to deformations of the ribs, or fasteners and substrate telegraphing through panels.
6. Trim pieces should be end-lapped with a minimum of (4") four inches. A strip of butyl tape and a bead of gun-grade sealant should be applied between the two pieces of metal to prevent weather penetration. The butyl tape should be applied approximately (2") two inches in from the edge for allowance of thermal expansion and contraction.

Proper Handling

1. General Handling – Each bundle should be handled carefully to avoid being damaged. Care should be taken to prevent bending of the panel or abrasion to the finish. Whenever possible, the bundle should remain crated until it is located in its place of storage. If bundles must be opened, we recommend you recreate them before lifting. To avoid damage, please lift the bundle at its center of gravity. CAUTION: Improper loading and unloading of bundles and crates may result in bodily harm and/or material damage. The Manufacturer is not responsible for bodily injuries and/or material damages resulting from improper loading and unloading.
2. Mechanical Handling – A forklift may be used for panels up to 20'-0" long. Please make sure the forks are at their maximum separation. Do not transport open bundles. When transporting bundles across rough terrain, or over a longer distance, some means of supporting the panel load must be used. A spreader bar should be used when lifting panels with lengths greater than 20'-0". Please be sure to ensure an even distribution of the weight to the pick up points. As a rule, when lifting panels, no more than 1/3 of the length of the panel should be left unsupported. Never use wire rope because of the high likelihood of damage to the panels.
3. When handling painted steel, care should be taken to prevent scratching of material. Clean gloves should be worn at all times to prevent a reaction with salts found on bare skin. Installers should wear rubber sole shoes to keep from scuffing material while walking on the roof. Handling of individual panels should be done carefully and properly to avoid bending or damage. Architectural panels should be carried by grasping the edge of the panel so that the panel is vertical to the ground. The Architectural panel should not be carried with the panel horizontal to the ground, as this could cause the panel to buckle or bend in the center. Normally, individual panels can be handled by people placed every 6'-0" to 8'-0" along the length of the panel.

StayLOC Architectural Steel Roof System INSTALLATION INSTRUCTIONS

Proper Storage

1. Please inspect panels for moisture accumulation. If moisture has formed, the panels should be unbundled, wiped dry, and allowed to dry completely. Once dry, carefully restack the panels and loosely recover allowing for ample air circulation.
2. Bundled panels should be stored high enough off of the ground to allow for air circulation and prevent contact with accumulating water. Elevate one end of the bundle to allow any moisture to run off the panels. The Manufacturer recommends covering the bundle with a tarpaulin. Do not use tight fitting plastic-type tarpaulins as panel bundle covers. While they may provide protection from heavy downpours, they can also retard necessary ventilation and trap heat and moisture that may accelerate metal corrosion. If panels are to be stored in possible bad weather, we suggest they be stored inside. Extended storage of panels in a bundle is not recommended. Under no circumstances should the panels be stored near or come in contact with salt water, corrosive chemicals, ash, or fumes generated or released inside the building or nearby plants, foundries, plating works, kilns, fertilizer, and wet or green lumber.
3. To facilitate the handling of Architectural panels, panel bundles can be lifted and placed on the roof. **Loading capabilities of the structure must be checked.** When lifting packaged panels, make certain they are adequately supported. Panels less than 20'-0" in length can normally be lifted with a forklift; however, when lifting panels in excess of 20'-0", it is recommended that a spreader bar and slings be used. As a rule, when lifting, no more than 1/3 of the length of the panel should be left unsupported. Make a plan for bundle placement by determining how much area a bundle of panels will cover. Bundles should be placed on the roof in accordance with the direction the panels will be installed. Consider where the string line, if any, is to run at the eave to set roof panels by. Roof bundles should not interfere with this string line.

StayLOC Architectural Steel Roof System INSTALLATION INSTRUCTIONS

Installation Tools & Equipment

To ensure safety and ease of installation, the following equipment and tooling is suggested, but not limited to:

1. Safety glasses.
2. Work gloves appropriate for handling metal.
3. Carpenter hammer.
4. Tape measure.
5. Metal cutting scissors (electric, air, or handheld).
6. Chalk line. **(DO NOT USE RED OR ORANGE CHALK)**
7. Screw gun (electric or air).
8. Saw horses or equivalent (to support panels while cutting or working).
9. Electric drill, 3/8".
10. Electric drill, 3/8" masonry.
11. Drill bits, 1/16" thru 1/4".
12. Drill bit, 1/4" masonry.
13. Carpenter square.
14. Angle finder (to determine angle of panel cuts on dormers and other obstacles).
15. Straight edge (for marking cut lines).
16. Wax pencil or equivalent (suitable for marking on painted steel).
17. Hemming tool.
18. Pop rivet gun.
19. Caulk gun.
20. Rubber mallet.
21. Panel shear.

StayLOC Architectural Steel Roof System

INSTALLATION INSTRUCTIONS

Installation Methods

1. Install eave and valley trim along with other items required before starting panel installation.
2. **ROOFING:** Begin panel installation by laying the first panel square with the eave, which is at the downwind end of the roof, the furthest from the direction of prevailing winds.

To aid in water run-off, roofing panels must be at least flush with the outermost edge of the roof edge trim or allowed an overhang at the eave beyond the outer edge of the roof edge trim. An overhang of (1") one inch to (2") two inches is typical when allowing panels to overhang. At the gable edge, apply a standard side rake trim or rake wall flashing if gable is against a wall. This will guard against lifting in high winds and provide a finished appearance. Refer to installation details for proper fastening schedule.

3. **BENDING AND BOWING:** Roofing and siding building panels are manufactured from extremely hard tempered metal for maximum strength. If a sheet must be bent, use caution when forming the metal around sharp bends. A gentle 90-degree bend is easily accomplished as long as any major ribs have been notched to allow for bending. If a rib is in the path of the desired bend line and not notched to allow for bending, the panel will buckle and not allow for a straight or cosmetically pleasing bend. Metal should not be re-bent once it has been formed. Metals rated higher than Grade 50 (50 ksi) should not be folded back onto themselves, so they are not able to take a hem. All StayLOC building panels are fabricated from Grade 50 steel unless otherwise specified by the customer. Therefore, StayLOC panels may be folded back onto themselves for applications requiring a hem. Where a metal roofing panel must be bent to conform to a curved roof, wood screws should be driven at every overlapping rib at the sheet ends to resist the natural tendency of the metal to lay straight. Standard fastening spacing is permitted over the rest of the panel. When installing StayLOC steel roofing over a curved arch, the minimum radius of the arch should be no less than 24'-0". Apply sealant tape or caulking at all side-laps, as needed.
4. **FASTENING:** The recommended tool type is a depth locating nose or adjustable clutch on a screw gun to prevent overdrilling and strip out. **DO NOT USE IMPACT TOOLS OR RUNNERS.** When seating the washer, apply sufficient torque to just seat the washer, do not overdrive the fastener. To prevent wobbling, make sure the fastener head is completely engaged in the socket. If the head does not go all of the way into the socket, tap the magnet deeper into the socket to allow full head engagement. Metal chips will build up from drilling and should be removed from time to time. Push only hard enough on the screw gun to engage the clutch. This prevents excess friction and burn out of the drill point. Correct pressure will allow screw to drill and tap without binding.
5. **CUTTING METAL PANELS:** A portable shear is especially recommended for cutting perpendicular across the panel profile of galvalume steel. When cutting painted products, other than with a shear, the sheet should be turned reverse side up in order that the metal particles and filings do not become embedded and cause rust marks on the face of the panel. Panels should be cut in a location such that the metal particles and filings from cutting will not settle on the other panels. In addition, all cut panels should be thoroughly brushed after installation to insure the removal of all metal particles and filings. Metal snips are sometimes used; however extra care should be taken to maintain uniformity. The Manufacturer recommends that a portable shear be used for cutting panels to length. It is also recommended the safety glasses and protective ware be worn when cutting metal. **CAUTION** – All product surfaces should be free of debris at all times. Installed surfaces should be wiped clean at the end of each work period. Never cut panels over metal surfaces. Metal shaving will rust on the surface, voiding the warranty.

StayLOC Architectural Steel Roof System INSTALLATION INSTRUCTIONS

Installation Methods

6. **TOUCH-UP PAINT:** All painted panels and flashings have a factory applied oven cured finish. Handling and installing panels may result in some small scratches or nicks to the paint finish. Touch-up paint is available in matching colors from the Manufacturer. It is recommended that a small brush be used to apply touch-up paint to those areas that are in need of repair. Touch-up paint does not have the superior chalk and fade resistance of the factory applied paint finish and will normally discolor at an accelerated rate. Never spray aerosol paint directly onto the panel surface due to overspray that will occur.
7. **BUILDING DESIGN AND CONSTRUCTION:** To insure adequate performance and longevity, the metal panel must be protected from potentially corrosive materials. The Manufacturer does not recommend panels be installed over green or damp lumber. However, if installing panels over green or damp lumber, a vapor barrier must be installed to separate the panels from the wood. Likewise, dissimilar metals with the exception of stainless steel also require a protective barrier between them before being joined.

Plastic, builder's felt, or bituminous paint may be use as a vapor barrier between the wood and metal panel. In addition to these materials, asphalt, caulking compound, or gasket material may be used to separate dissimilar metals. Porous insulation board may absorb and retain moisture. Because of this, a vapor barrier is required similar to that described above for separating metal from green or damp wood. This vapor barrier should be installed such that moisture is prevented from contacting both the insulation and the metal panel.

Fertilizer, lime, acids, feeds, manure and soils also have a potential to initiate corrosion in a metal panel. These and any other potentially corrosive chemicals and materials should be adequately insulated from contact with the metal panels.

StayLOC Architectural Steel Roof System INSTALLATION INSTRUCTIONS

Material List

The following materials and fastening methods will be required for the installation of StayLOC panels. These items are recommended but are not limited to the ones shown in the chart below. It may be necessary to employ other methods and materials depending upon design and application.

Screw Fasteners

The fasteners listed below are considered standards. The use of same style or type of fastener, which is larger, and of an equivalent length or longer length is acceptable. An example would be to substitute a #10 x 1-1/4" for a #10 x 1". However, the performance of the roofing panels is based upon the use of the fasteners listed below. Typically, using a larger fastener will improve performance; however, before substituting fasteners, check with an engineer or architect as well as any applicable local and state code requirements.

	Size	Type	Finish	Application
A	#9 x 1"	HWH w/ sealing washer	Galvanized	Pnl to roof
B	#9 x 1-1/2"	HWH w/ sealing washer	Galvanized	Pnl to roof
C	#9 x 2-1/2"	HWH w/ sealing washer	Galvanized	Pnl to roof
D	#10 x 1"	Pancake Head	Galvanized	Pnl to roof
E	#12 x 1-1/4"	HWH SD w/ sealing washer	Galvanized	Pnl to roof
F	#12 x 2"	HWH SD w/ sealing washer	Galvanized	Pnl to roof
G	#10 x 1"	Pancake Head SD	Galvanized	Pnl to roof
H	#14 x 7/8"	HWH SD w/ sealing washer	Galvanized	Pnl to Pnl

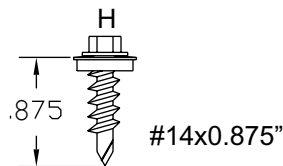
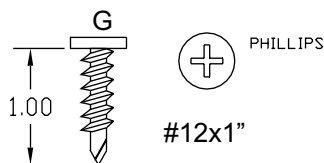
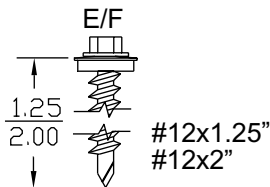
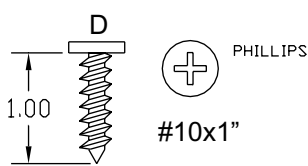
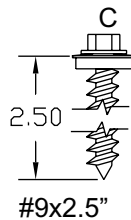
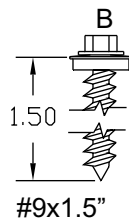
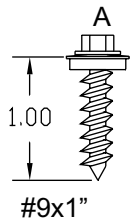

StayLOC Architectural Steel Roof System INSTALLATION INSTRUCTIONS

Various Fasteners, Flashing, and Sealants

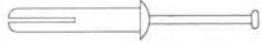

Masonry Anchor 1/4" X 1"



#43 Pop Rivet 1/8" Diam. X 3/16" L

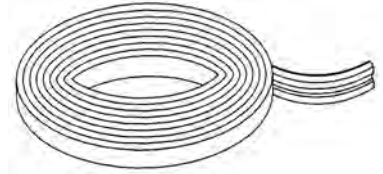

Butyl Tape Sealant
3/16" X 1" X 50'

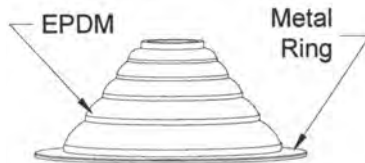

Rubber Pipe Boot
Weather-Resistant and UV-Resistant
Available in Various Sizes



Gun Grade Acrylic Sealant

StayLOC Architectural Steel Roof System INSTALLATION INSTRUCTIONS

Trim Parts & Accessories

All trim parts and accessories are fabricated from 26- or 24-gauge pre-painted steel with a Kynar or SMP paint, .032 pre-painted aluminum with a Kynar paint. Custom profiles are available. See your ABC Supply dealer for pricing and delivery.

Listed with dimensions:

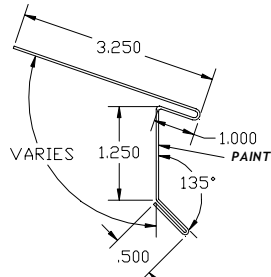

Drip Edge - LDE6

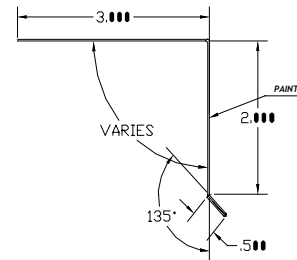

Rake Edge - LRE6

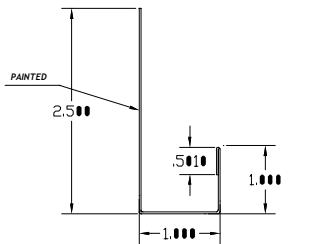

J-Closure - LJC6

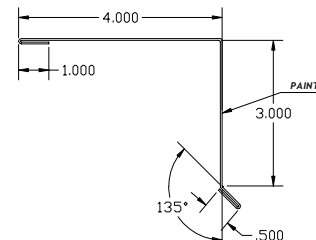

Side Rake Conc. - LSRC6

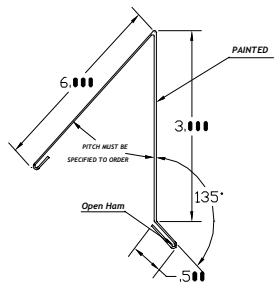

Peak Wall - LPW6

StayLOC Architectural Steel Roof System INSTALLATION INSTRUCTIONS

Trim Parts & Accessories

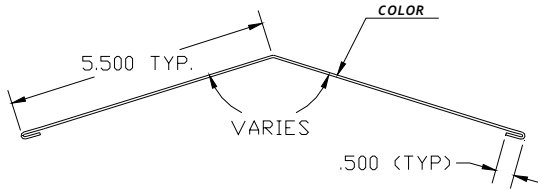

Ridge Cap (12") – LRC6—

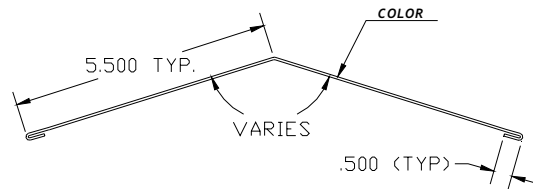

Hip Cap (12") – LHC6—

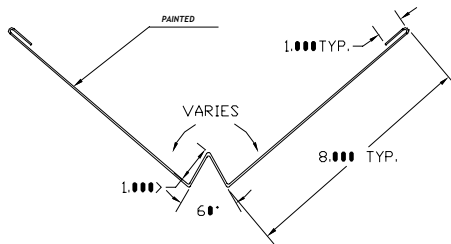

"W" Valley – LWV6—

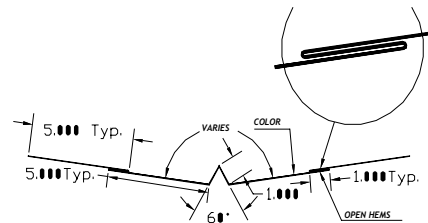

"Locking" "W" Valley L – LWVL6—

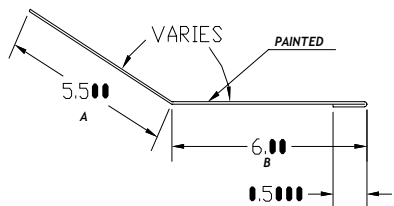

Pitch Transition – LPT6—

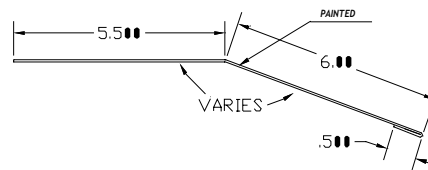

Gambrel Transition – LGT6—

StayLOC Architectural Steel Roof System INSTALLATION INSTRUCTIONS

Trim Parts & Accessories

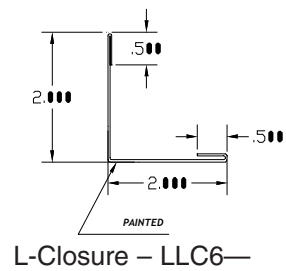
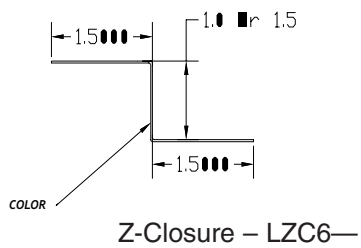
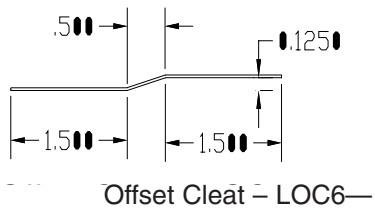
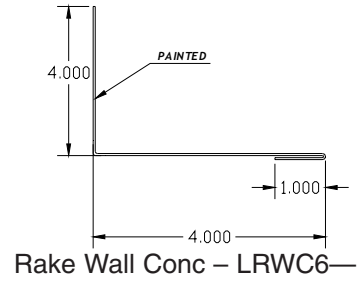
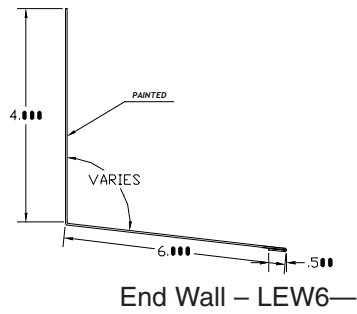

StayLOC Architectural Steel Roof System INSTALLATION INSTRUCTIONS

Designing Custom Trim Parts

The Manufacturer designed several standard trim parts which will address the most common roofing applications; however, many jobs will likely require some custom flashing to address specific architecture. In these cases, it is the responsibility of the installer to design a trim part to meet the application need. When designing custom trim parts, they will likely resemble a standard trim part profile but with slight dimensional variations. Others may require a completely new profile. Whether designing modified trim parts or new trim parts altogether, it is important to follow the guidelines below to best communicate your needs.

1. Always specify the flat start width or girth of the part (include hems on part).
2. Dimension all part sections from start edge of part to first bend, then from last measured bend to the next bend, and so on until all sections are dimensioned to the end edge of the part.
3. Dimension all bend angles from section line to section line.
4. Never dimension parts to non-existing or invisible lines.
5. All hems will be ½” and must be specified on part start and ending edges (if required). For hems other than ½”, consult the Manufacturer’s sales representative.
6. Always specify the side that the “finish” or “paint” should be on.
7. Always specify the gauge and color of parts.
8. All custom parts come in 10’-0” lengths. For lengths other than 10’-0”, consult the Manufacturer’s sales representative.

Use the “Roof Pitch Angles” information below to assist in trim part design. The Manufacturer’s flat sheet stock is also available for on-site custom trim fabrication. See the trim part dimensional example below.

Example:

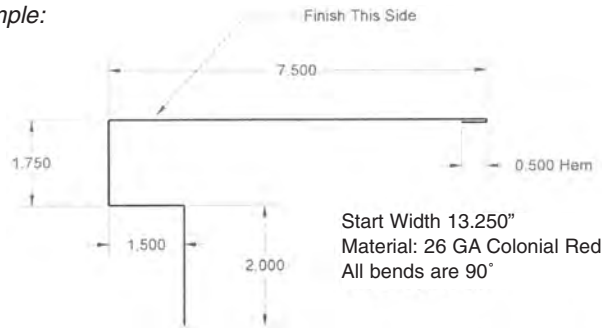

Roof Pitch Angles

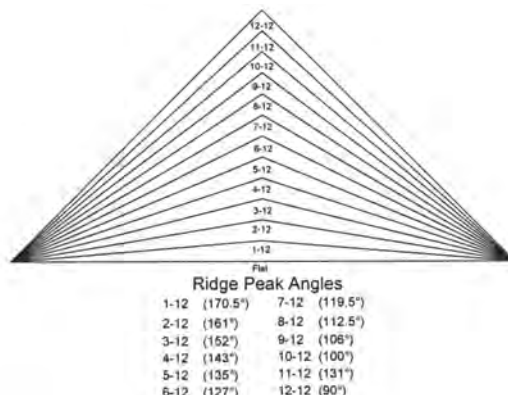
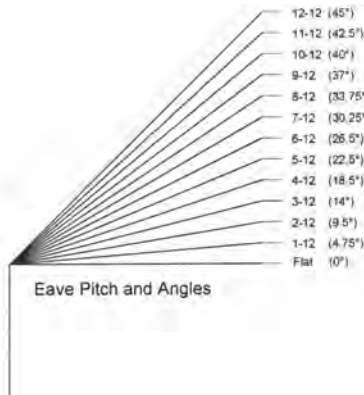

StayLOC Architectural Steel Roof System INSTALLATION INSTRUCTIONS

Fastening

StayLoc Panels

StayLOC panels employ clip fastening, equally spaced along the male rib as shown below.
(Clip spacing should be 12" on center for the first 3'-0" of panel length)

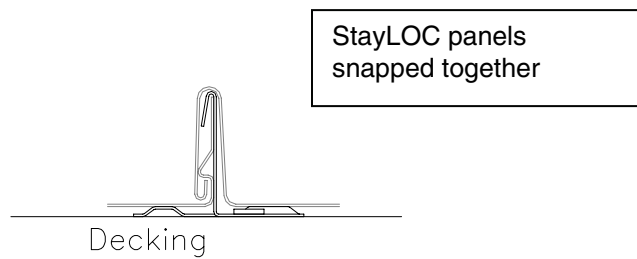
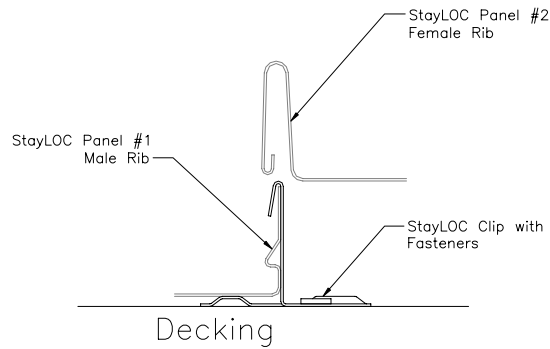
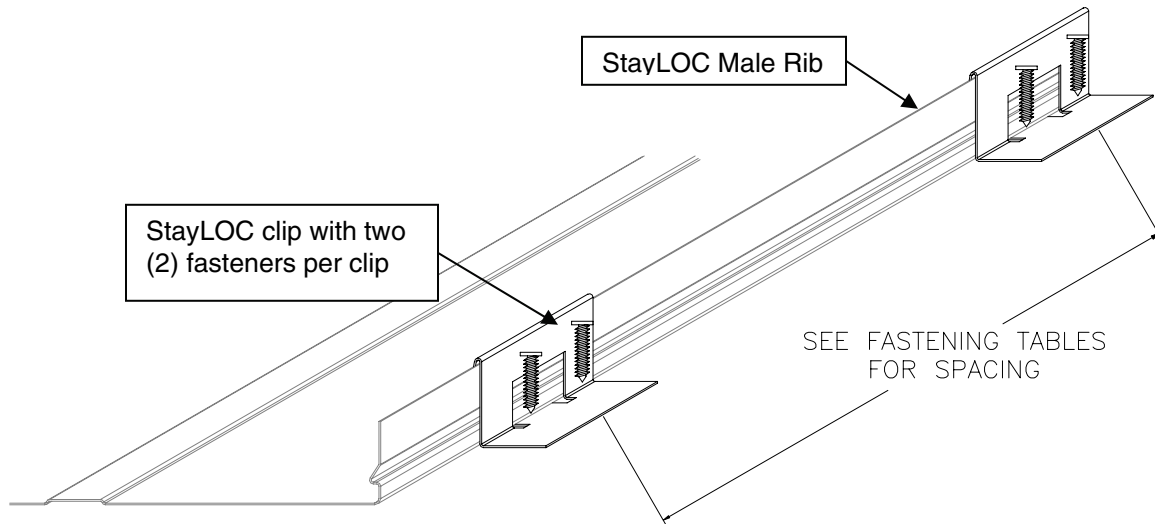

StayLOC Architectural Steel Roof System INSTALLATION INSTRUCTIONS

Fastening

Fastener Selection Tables

1-1/2" StayLOC panels over Wood Decking

Wood Grip Screws – Pancake Head, #10 x 1"

Based upon UL 580 testing **without** urethane/adhesive sealant along fastening tab.

1-1/2" Rib - 16" Spacing KenLOC	19/32" Min. CD APA rated Plywood Decking		
	12" Spacing	24" Spacing	36" Spacing
30 PSF	Good	Good	Good
50 PSF	Good	Good	Good
70 PSF	Good	Good	Good
90 PSF	Good	Good	Good

*** UL 1897 uplift rating of 225 psf.

Note: Clip spacing to be 12" on center for the first 3'-0" of panel length

Panel attachment at the eave if hemmed panel end not used.

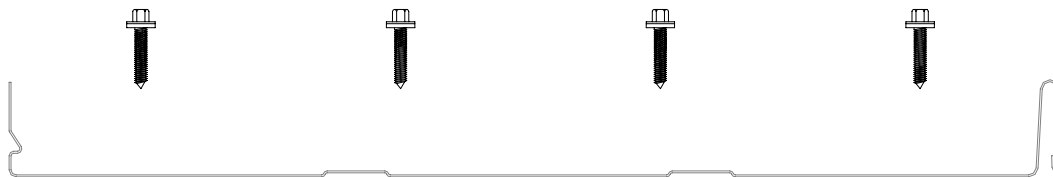

Ribbed, Striated or Smooth

Fastening Pattern for the 16" StayLOC panel.
Four (4) equally spaced fasteners between ribs.

StayLOC Architectural Steel Roof System

INSTALLATION INSTRUCTIONS

Fastening

General Fastening Guidelines

1. Valley Applications

As the StayLOC panels converge into a valley, the proper fastening method is to cut the valley end of the panel to allow for a 1" hem to be bent. The valley should already have either a "locking" hem or offset cleat already set in place. Additional sealing of fasteners, valley/panel lap, and panel ribs is recommended to help ensure weatherproof installations. Refer to the installation illustrations of valley applications for more detail.

2. Trim Parts and Accessories

After installing the panels, most finishing trim and accessories are installed to complete and weatherproof the installation. Fasteners are not to exceed more than twelve (12) inches on center for most applications. Refer to the installation illustrations of the standard applications for more detail. If you do not find your application addressed in the installation illustrations, consult your engineer or architect or Manufacturer's sales representative for an installation recommendation. Additional sealing of fasteners, closures, panel lap, and panel ribs are recommended to help ensure weatherproof installations.

3. Weather Resistant Fastening

To help insure that panels and fasteners are providing the best weather resistance, always seal panel edges such as eave, valley, ridge and similar applications with butyl tape and acrylic sealant. Take care to position fasteners so that they are driven either through the butyl tape or behind the butyl tape, meaning that the butyl tape is between the weather exposed panel edge and the fastener. If the fastener is placed in front of the butyl tape so that it is between the tape and the weather exposed edge, the potential for water penetration due to siphoning is greatly increased.

Pre-Installation Preparation

Sheathed Roofing Surfaces *(Refer to Illustration on page 20)*

1. All truss and roof construction must meet all applicable federal, state, and local codes. Ensure that all fasteners are flush or recessed into the decking material. Decking material and trussis should be staggered for best application. Decking material shall be a minimum of 19/32" thick and rated as structural sheathing.
2. Install the roof edge trim along the eave edge of the roof deck. Fasten into place with fasteners spaced eight (8) to twelve (12) inches on center. Fasteners should be positioned within a half (1/2) inch of the inside edge of the roof edge trim.
3. Install the first layer of #30 felt or #30 ASTM felt when code requires (24" minimum width) along eave line. Felt should be positioned to overlap roof edge trim, cover roof edge trim fasteners and allow one inch of outside edge of roof edge trim to be exposed. The roofing felt should be positioned to maintain a minimum cover of twelve (12) inches from felt edges to any covered decking material seams. Fasten roof felt into place as required to hold it until the roof panels are installed. Take care to ensure fasteners are flush or recessed with decking material. Do not over-fasten.
4. Install the second layer of roofing felt insuring that its bottom edge overlaps the top edge of the first layer by a minimum of six (6) inches. The roofing felt should be positioned to maintain a minimum of twelve (12) inches from the felt edge to any covered decking material seams. Fasten roof felt into place as required to hold it until the roof panels are installed. Take care to ensure fasteners are flush or recessed with decking material. Do not over-fasten.
5. Install the remaining layers of roofing felt following the procedure described in number four (4) above.
6. When installing the final piece of roofing felt, overlap felt a minimum of four (4) inches over the ridge onto adjoining side of roof. If utilizing a ridge vent, fold the roofing felt over into vent area, leaving a two (2) inch overhang into the vent area, rather than overlapping the ridge. Fasten into place.
7. Other type of underlayments are acceptable as long as they perform as the specified #30 minimum roofing felt.
8. A modified asphalt sheet or non-granulated ice & water shield sheet should be installed in the valleys positioned so (18") eighteen inches extends on either side of the center line of the valley. (36") thirty-six inch modified roll or non-granulated ice & water shield should be installed horizontally on the eave and vertically at the rake edge. Installation should be in accordance with the manufacturer's recommendations.

StayLOC Architectural Steel Roof System INSTALLATION INSTRUCTIONS

General Deck Installation

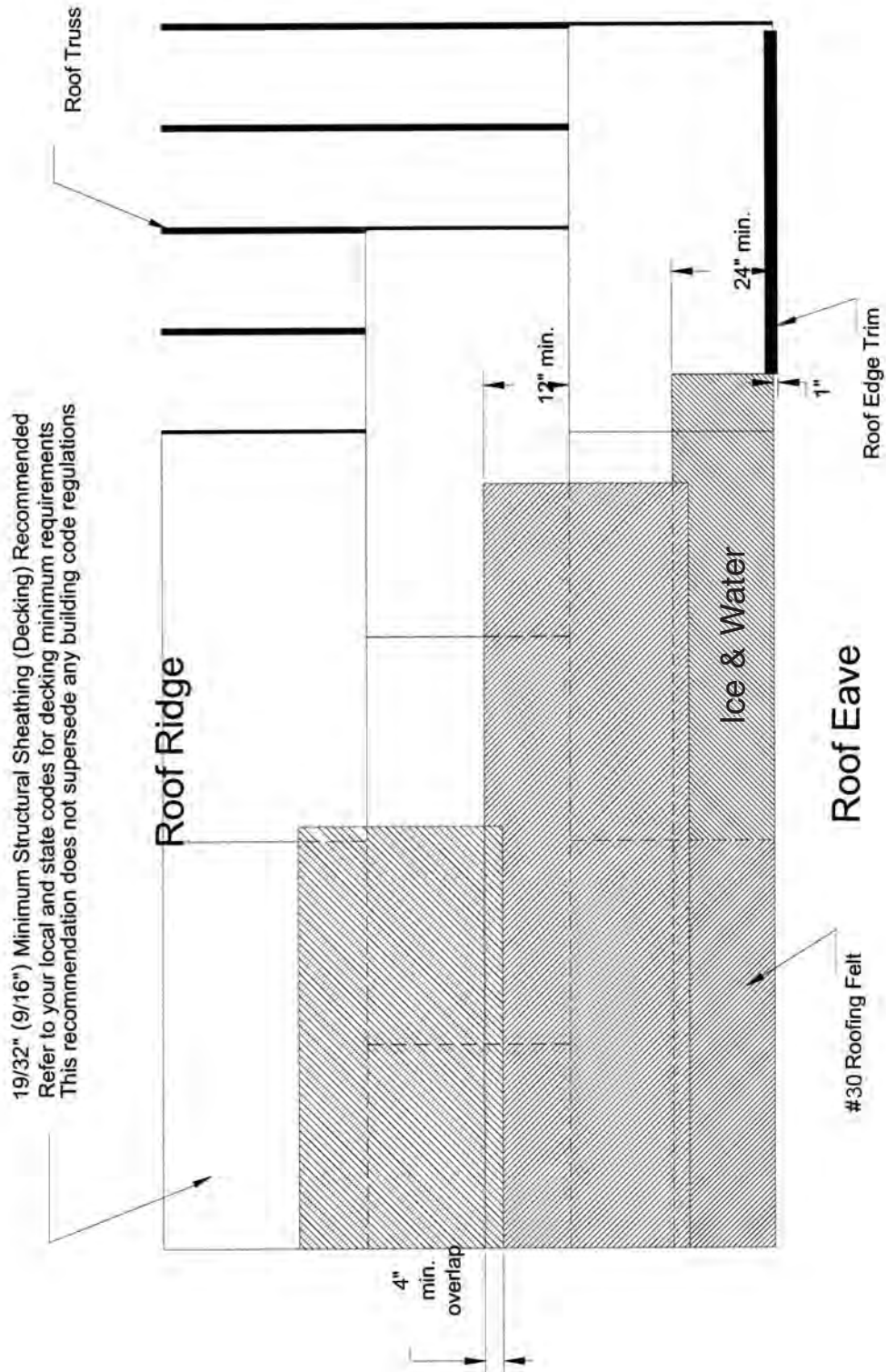

StayLOC Architectural Steel Roof System INSTALLATION INSTRUCTIONS

General Panel Installation

General Roof Application *(Refer to Illustration on Page 22)*

1. StayLOC panels are easily installed by overlapping the lap rib (female rib) over the purlin rib (male rib). Refer to various rib detail illustrations on page 22 for clarification of lap rib and purlin rib.
2. When installing over solid substrate, panel distortion may occur if not applied over properly aligned and uniform substructure. The installer should check the roof deck for squareness before installing Architectural panels. Several methods can be used to verify squareness of the structure for proper installation of the panels.
 - a. Method “A” – Measure diagonally across one slope of the roof from similar points at the ridge and eave and obtain the same dimension.
 - b. Method “B” – The 3-4-5 triangle system may also be used. To use this system, measure a point from the corner along the edge of the roof at a module of (3) three. Measure a point from the same corner along another edge at a module of (4) four. Then by measuring diagonally between the two points established, the dimension should be exactly a module of (5) five to have a square corner. Multiple uses of this system may be required to determine building squareness. If the endwall cannot be made square, the roof system cannot be installed as shown in these instructions.
3. After installing the roof edge trim and roofing felt as described in the Pre-Installation Preparation section, install a layer of 1” sealant tape along the outside edge of the roof edge trim.
4. Prior to installing any panels, consult your panel layout drawing, if supplied, for the building you are roofing. These drawings will show the correct panel lengths for various locations on the roof.
5. After consulting the panel drawing, measure the specified distance from the starting rake. Use a chalk line to mark the decking.
6. In order to simplify installation and keep the panels aligned, it is recommended that the installer measure a distance equal to (4) four times the panel width away from the starting edge (rake) and mark this point by striking a chalk line (guide line) from the ridge to the eave. This mark can be used as a guide during installation. The installer may wish to repeat this process every (4) four panels to limit any panel drift.
7. After putting a hem on the eave end of the panel, slide the first panel into place and align with the chalk line. Take care to ensure that the first panel is accurately aligned to prevent any panel drift on ensuing panels.
8. Fasten the panel into place using the fastening clips and two (2) #10 x 1” Pancake Head wood grip screws. Take care to ensure that the fasteners are flush with the surface of the clips. Do not over-drive fasteners; this could lead to stripping or metal failure during wind loading. Clips should be spaced per the Fastener Selection Tables on page 18 for the appropriate wind load requirements. Fastener spacing should never exceed the maximum allowable spacing as specified in the Fastener Selection Tables.
9. Install the next panel by positioning the lap rib over the purlin rib of the previous panel and align at eave end, referencing previous panel and roof eave line. Minor adjustments to the panel position can be made by lightly tapping the end of the panel with a piece of wood. Take great care not to damage the panel when tapping the ends. Once panel is properly positioned and ribs interlocked, fasten the panel into place in the same manner as on the first panel. Prior to fastening panels at eave line, insert the foam eave closure (if applicable) and fasten into place. Continue this process for all panels.
10. Reference the appropriate installation details for addressing vents, pipes, skylights, chimneys, and other commonly encountered obstacles.

StayLOC Architectural Steel Roof System INSTALLATION INSTRUCTIONS

General Panel Installation

General Roof Application (Cont.)

11. Maintain a straight, even line at the roof eave line. In order to accomplish this, it is critical that the first panel is perpendicular to the eave line. Additionally, the installer should take caution to prevent spreading of the panels during installation.
12. Refer to the “Fastener Selection Table” for panel attachment at the eave and ridge ends of the panels. Prior to attaching the eave fasteners, install any applicable foam eave closures into position. Secure the eave or ridge ends of the panels using the appropriate type and quantity of fastener. Take care not to under tighten or over tighten the fasteners, either could result in potential water penetration. The foam or metal ridge closures must be put into place prior to installing the ridge cap. Refer to the ridge installation detail.
13. Refer to the Installation Details section starting at page 24 for detailed illustrations of trim and flashing installation for many of the most commonly encountered installation applications.

NOTE: Refer to “Fastener Selection Tables” on page 18 for the appropriate wind load requirements. Clip spacing should never exceed the maximum allowable spacing as specified in the tables. ALWAYS install panels with the panel lap away from prevailing wind and rail.

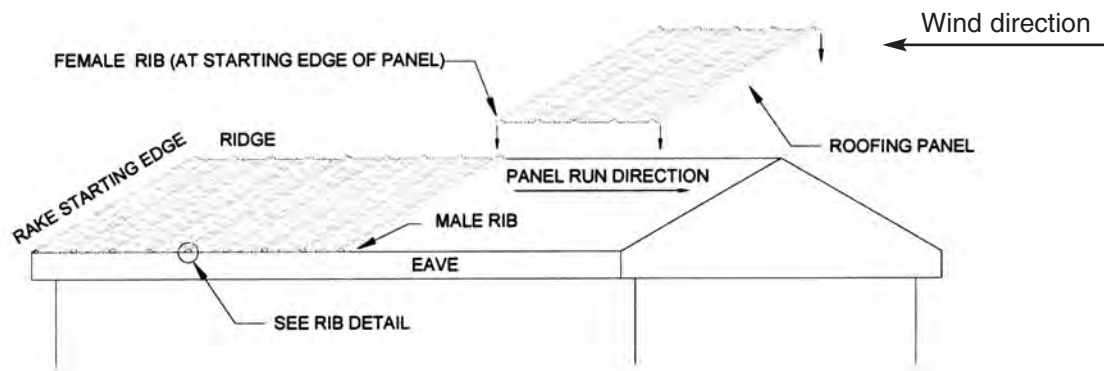

StayLOC Architectural Steel Roof System INSTALLATION INSTRUCTIONS

Building Overview

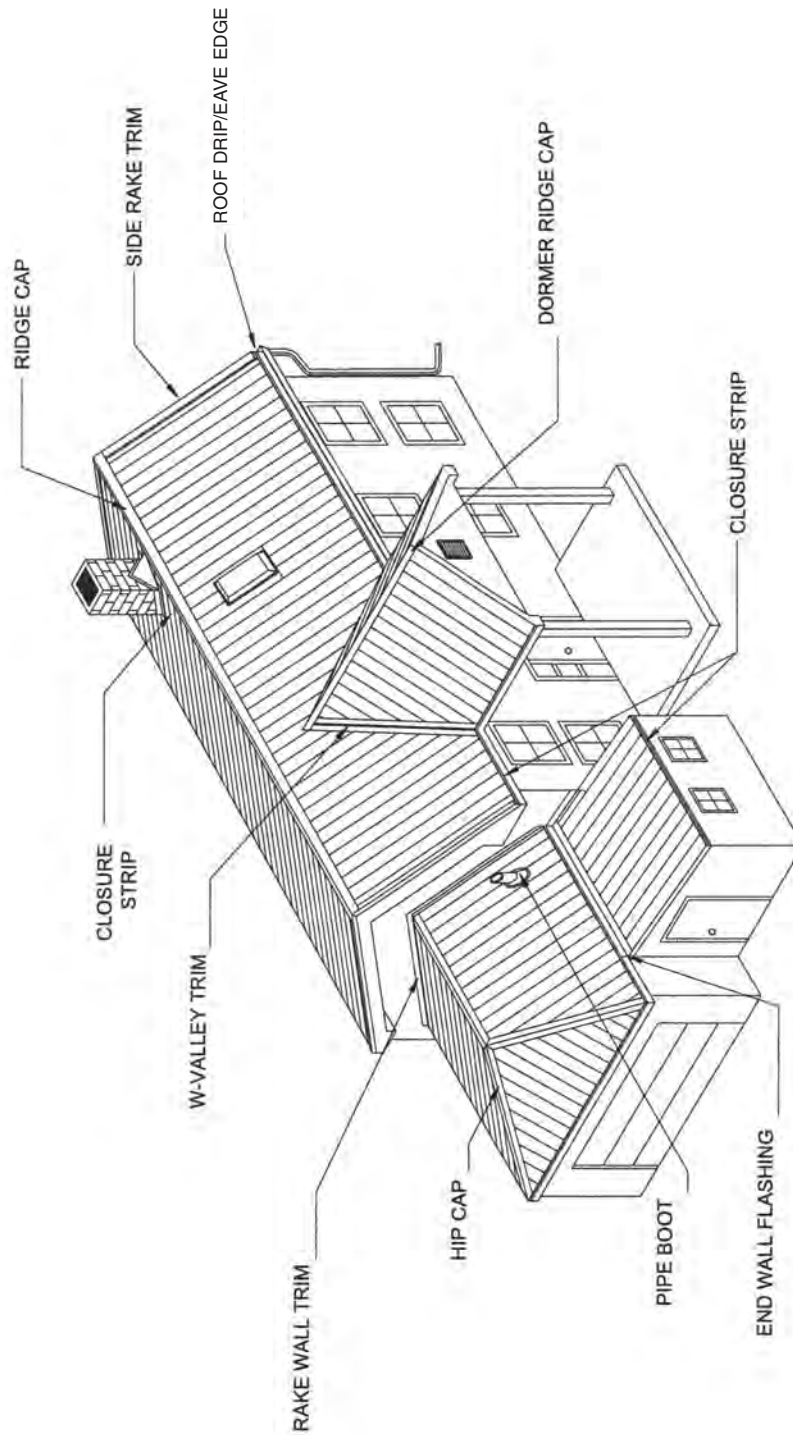

StayLOC Architectural Steel Roof System INSTALLATION INSTRUCTIONS

Installation Details

Standard Eave Detail

See hemmed over eave detail for concealed fastener installation (Page 29)

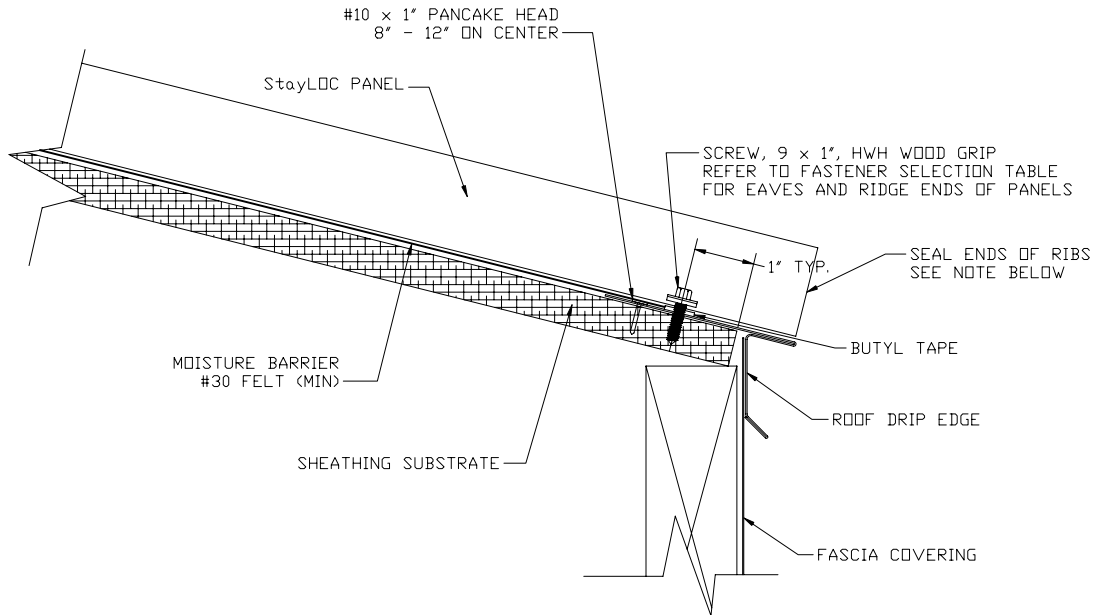

Eave Detail with Gutter

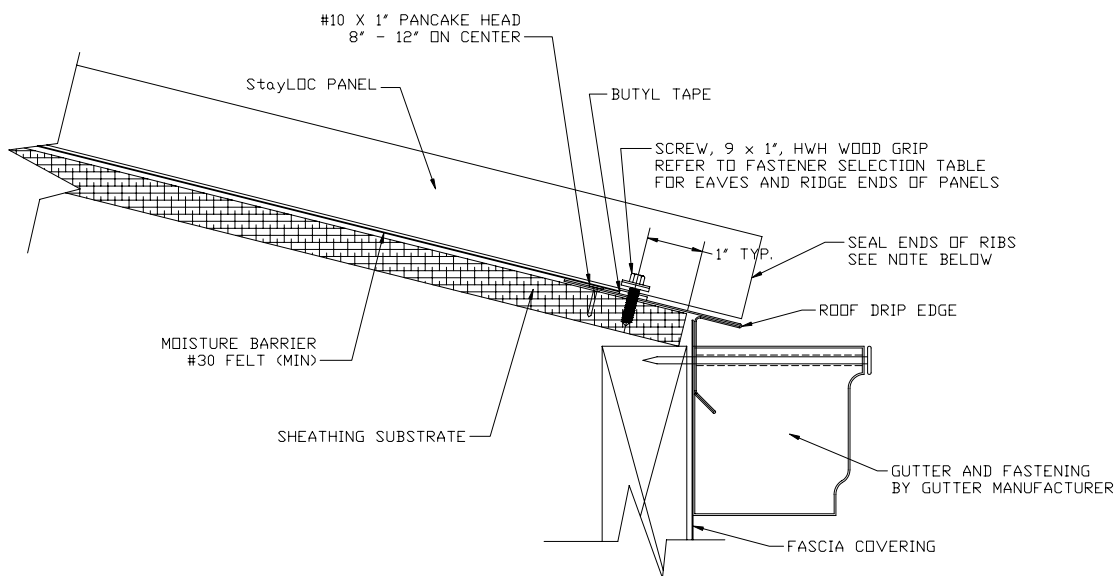

NOTE: It is recommended that all major panel rib ends and panel side or end laps be sealed with a gun-grade acrylic sealant and/or closures to deter insect and water penetration.

StayLOC Architectural Steel Roof System INSTALLATION INSTRUCTIONS

Installation Details Formed Valley Detail

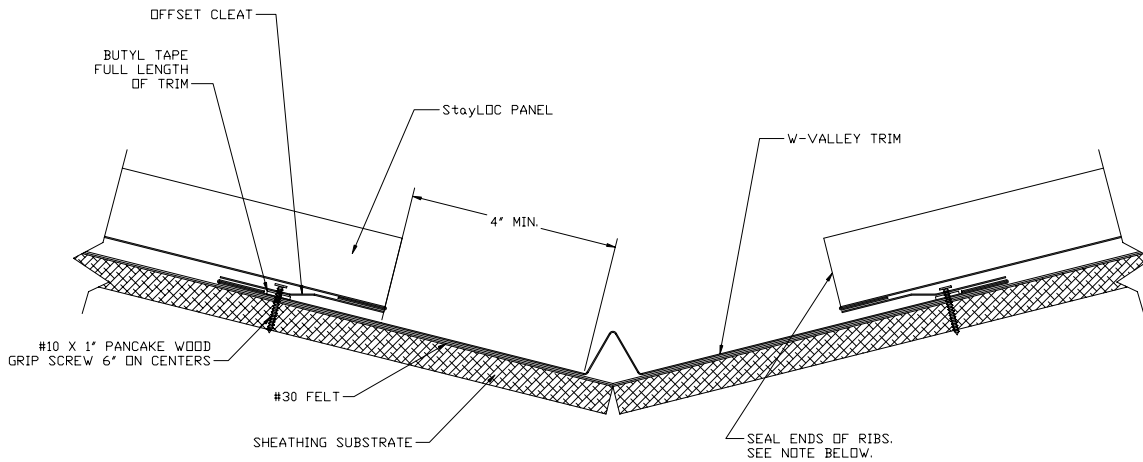

Peak Detail

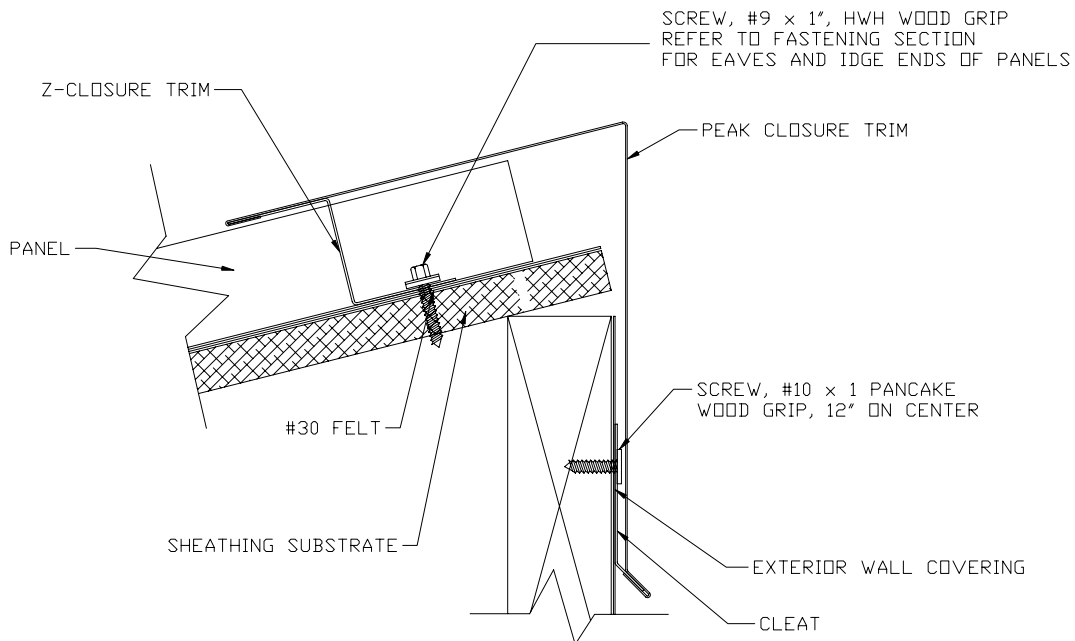

NOTE: It is recommended that all major panel rib ends and panel side or end laps be sealed with a gun-grade acrylic sealant and/or closures to deter insect and water penetration.

StayLOC Architectural Steel Roof System INSTALLATION INSTRUCTIONS

Installation Details

Hip Detail

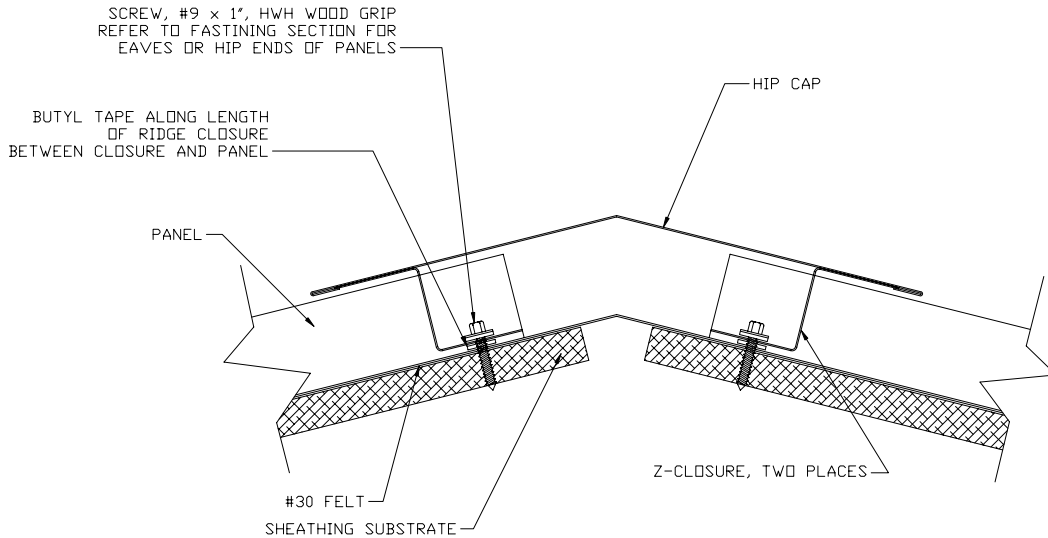

Ridge Cap

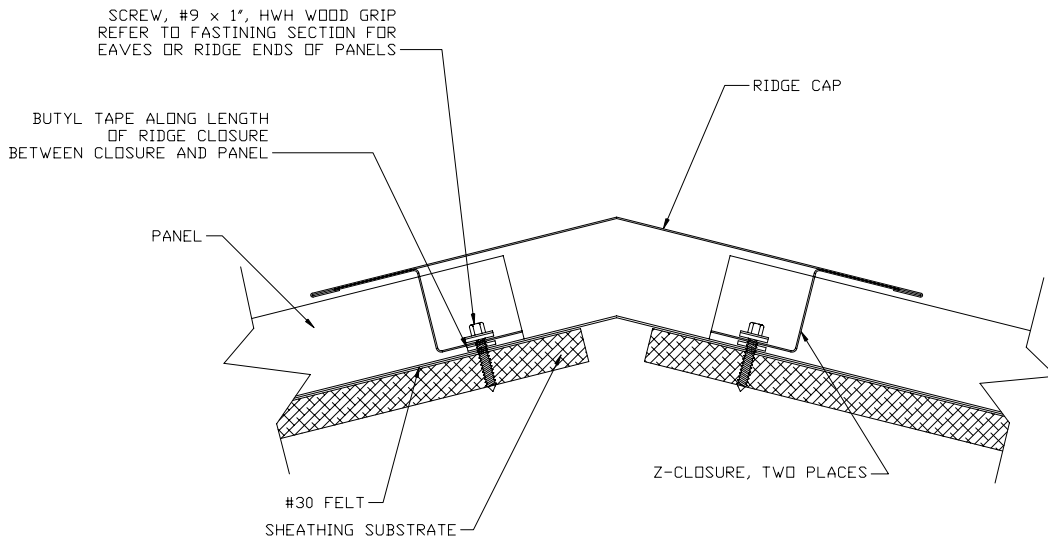

NOTE: It is recommended that all major panel rib ends and panel side or end laps be sealed with a gun-grade acrylic sealant and/or closures to deter insect and water penetration.

Stay LOC Architectural Steel Roof System INSTALLATION INSTRUCTIONS

Installation Details

Rake Wall Detail

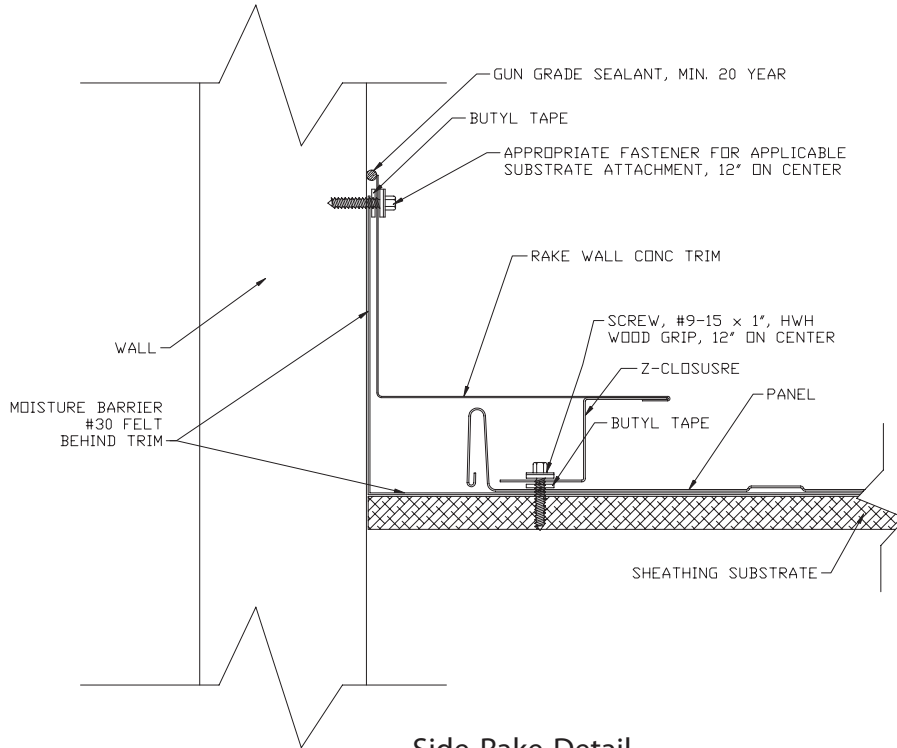

Side Rake Detail

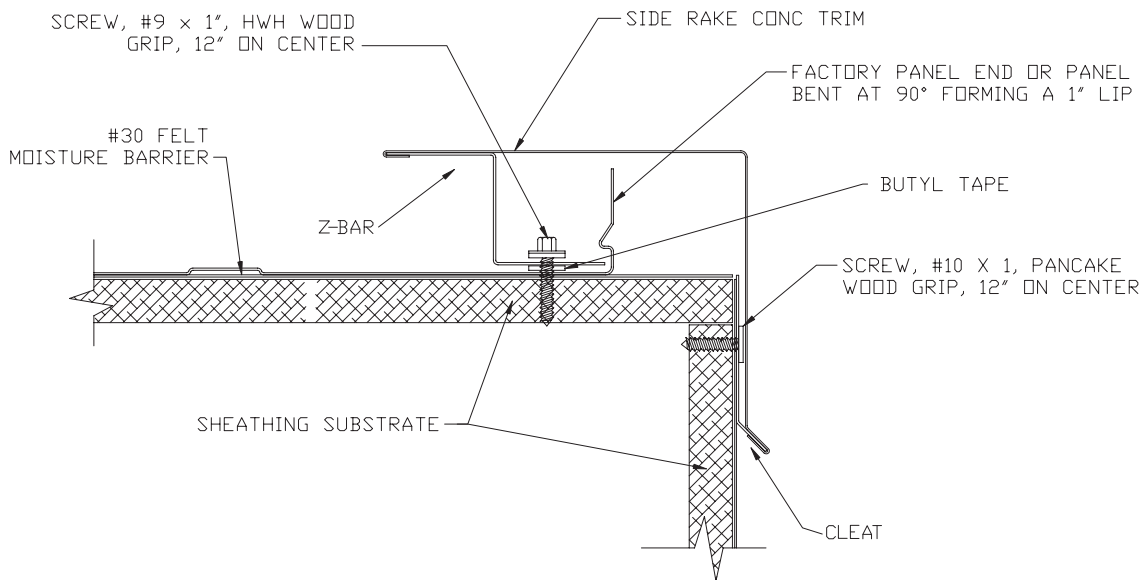

NOTE: It is recommended that all major panel rib ends and panel side or end laps be sealed with a gun-grade acrylic sealant and/or closures to deter insect and water penetration.

StayLOC Architectural Steel Roof System INSTALLATION INSTRUCTIONS

Installation Details

End Wall Detail

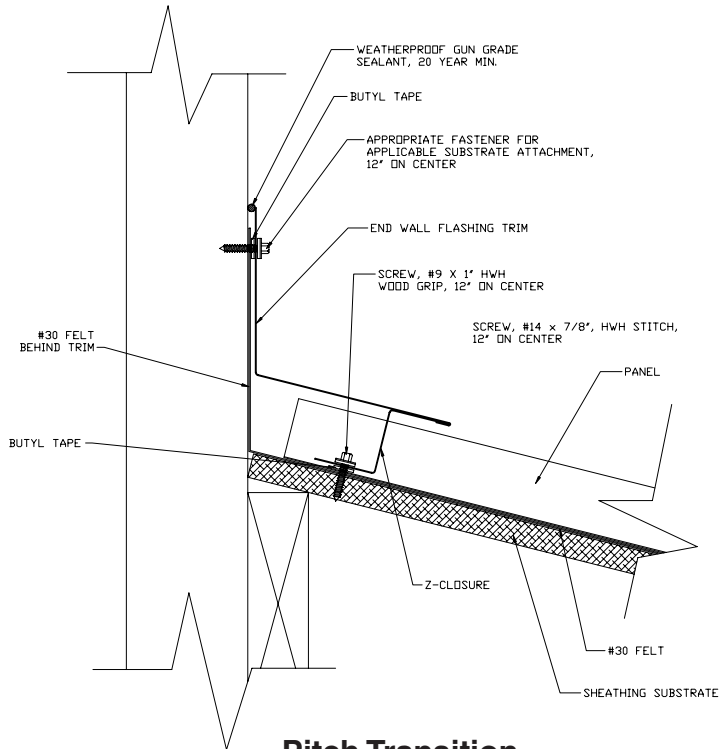

Pitch Transition

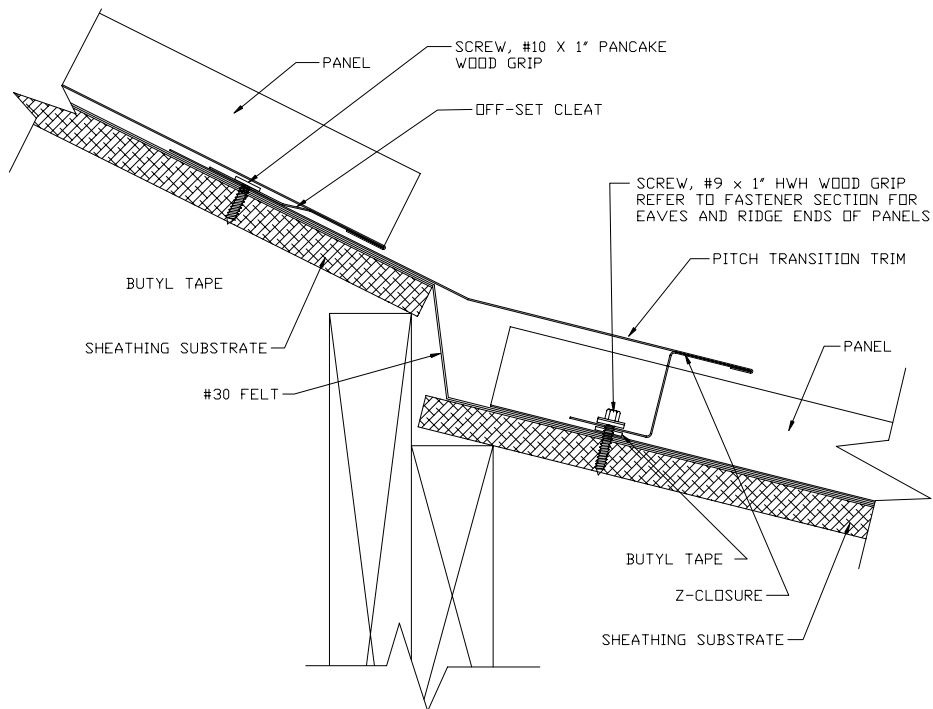

NOTE: it is recommended that all major panel rib ends and panel side or end laps be sealed with a gun-grade acrylic sealant and/or closures to deter insect and water penetration.

StayLOC Architectural Steel Roof System INSTALLATION INSTRUCTIONS

Installation Details Gambrel Transition

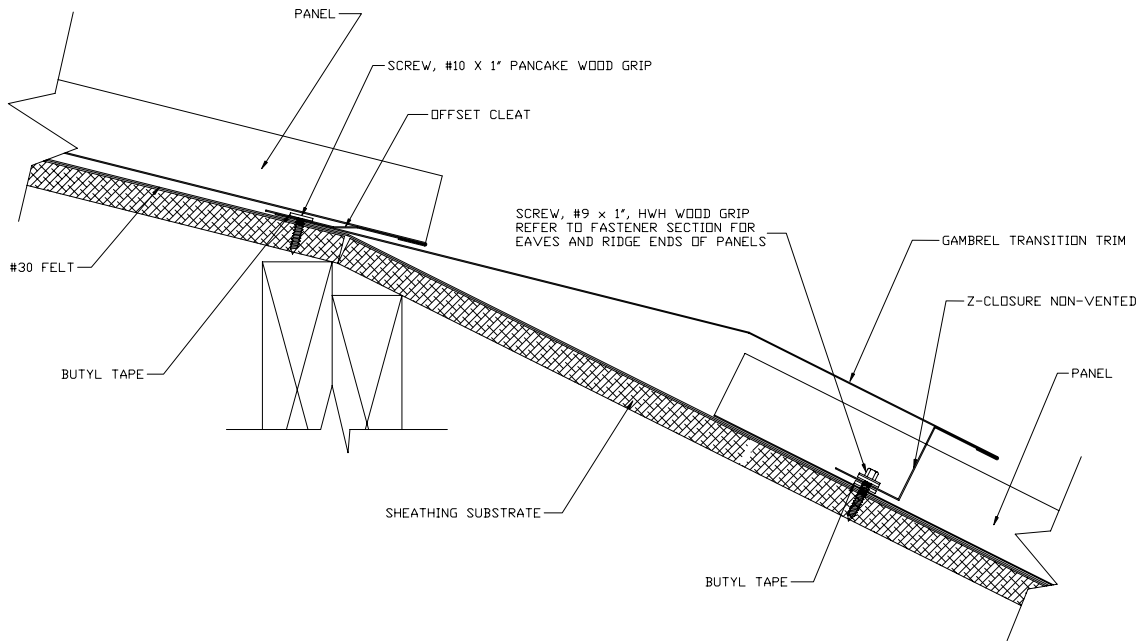

Hemmed Over Eave Detail

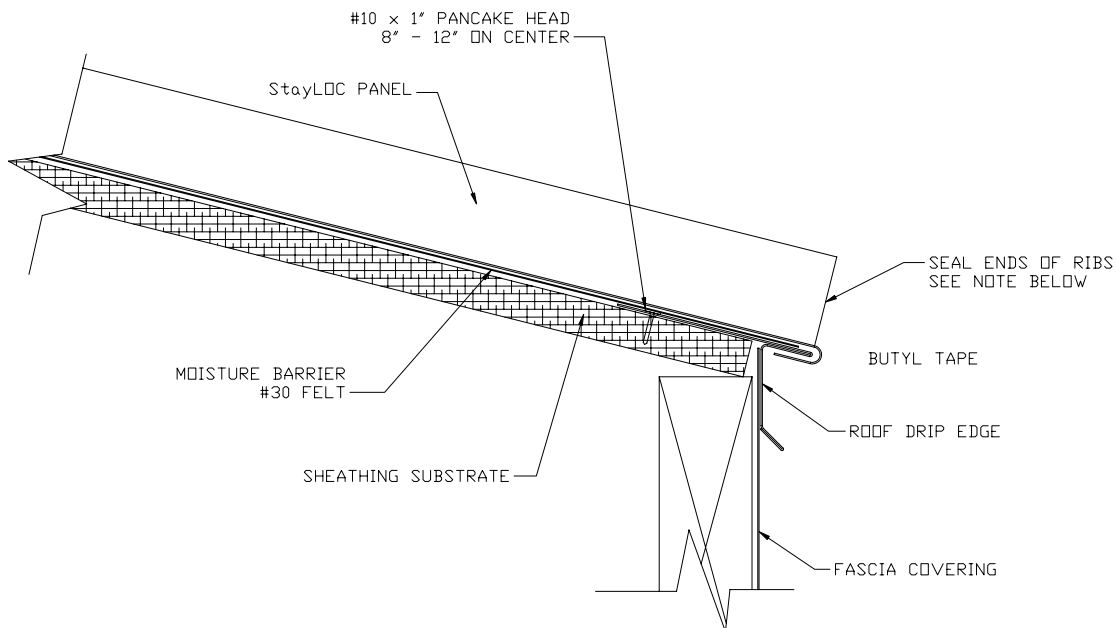

NOTE: It is recommended that all major panel rib ends and panel side or end laps be sealed with a gun-grade acrylic sealant and/or closures to deter insect and water penetration.

StayLOC Architectural Steel Roof System INSTALLATION INSTRUCTIONS

Installation Details Hen Bending Details

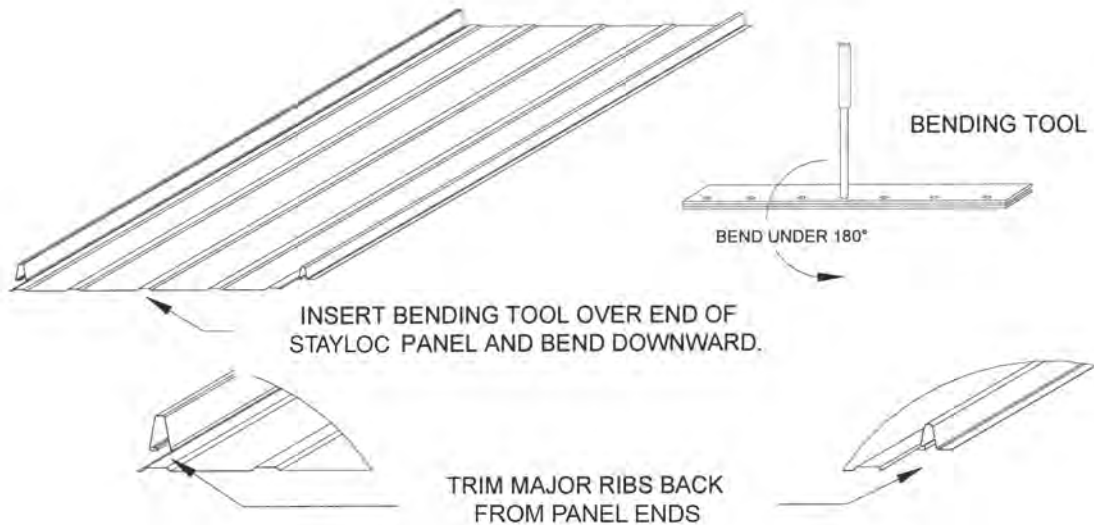

Pipe Penetration

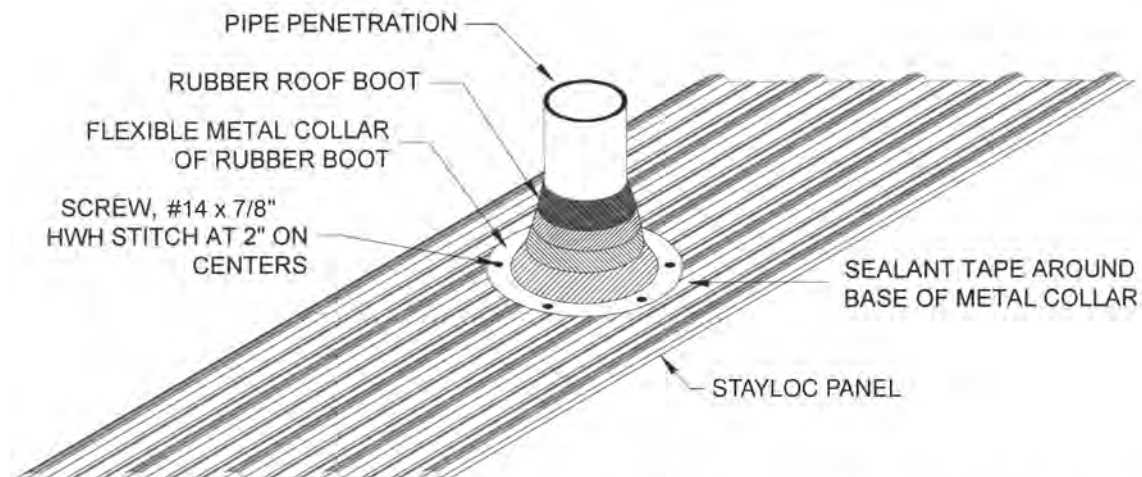

*** WHENEVER POSSIBLE, LOCATE PIPE PENETRATION SO IT PASSES THROUGH THE CENTER OF THE ROOFING PANEL AND AWAY FROM THE OVERLAPPING RIBS.

CAREFULLY FOLLOW THE INSTALLATION INSTRUCTIONS PROVIDED WITH THE PIPE BOOT BY THE BOOT MANUFACTURER. ALWAYS CUT HOLE IN BOOT AT LEAST 1/8" SMALLER THAN DIAMETER OF PIPE.

NOTE: It is recommended that all major panel rib ends and panel side or end laps be sealed with a gun-grade acrylic sealant and/or closures to deter insect and water penetration.

StayLOC Architectural Steel Roof System INSTALLATION INSTRUCTIONS

Installation Details

Skylight and Large Vent Penetration

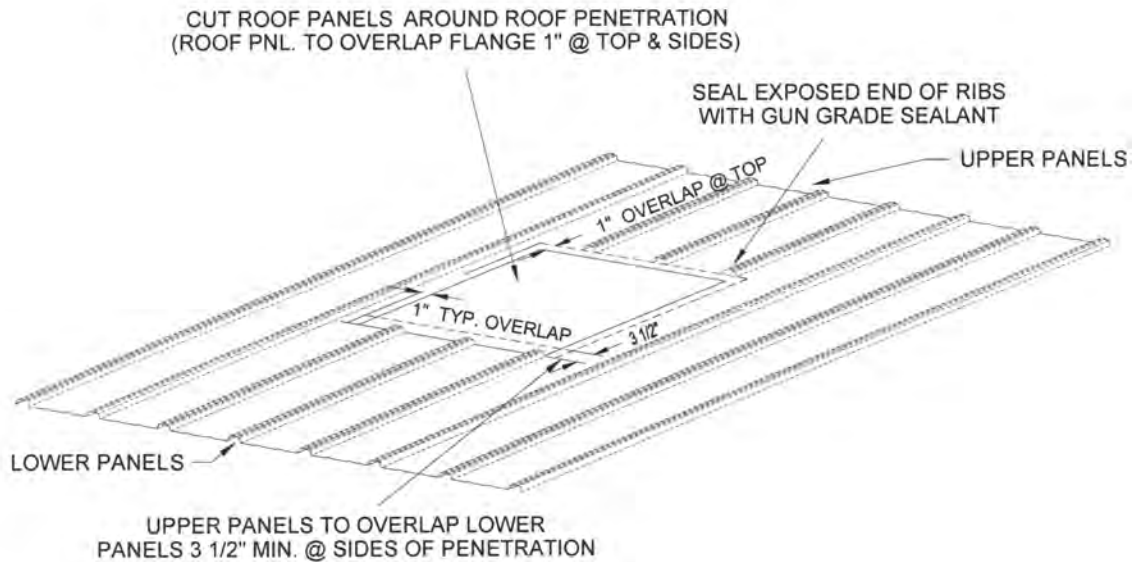

Skylight and Large Vent Penetration

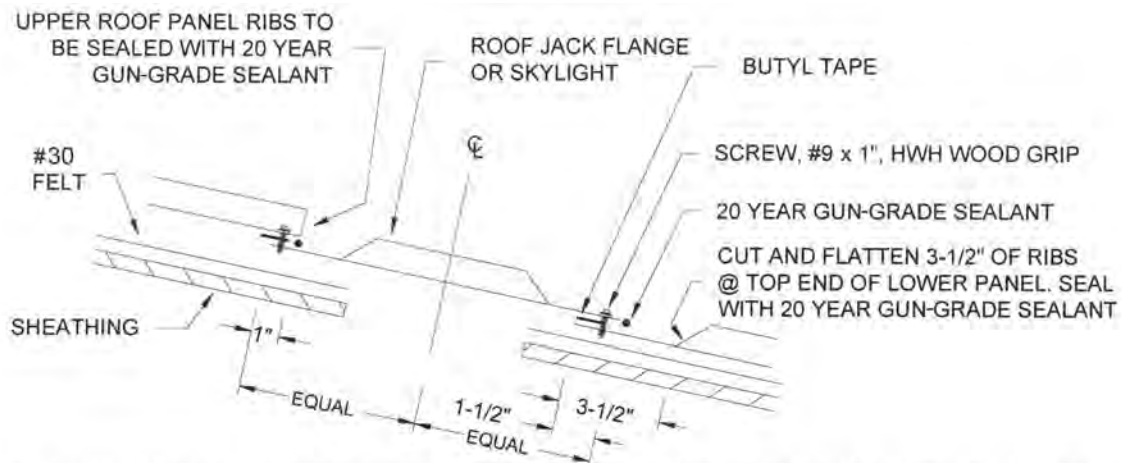

1. IF THE ROOF PENETRATION IS SUCH THAT A RIB FALLS WITHIN THE 1" THAT OVERLAPS AT THE SIDE OF THE FLANGE/SKYLIGHT, ADJUST FLANGE/SKYLIGHT TO MISS RIB, A MIN. OF 1".
2. ROOF PANELS SHOULD OVERLAP FLANGE/SKYLIGHT 1" MIN. AT TOP AND SIDES.
3. FLANGE/SKYLIGHT SHOULD RUN OVER BOTTOM PANEL MIN. 2".
4. BUTYL TAPE TO BE USED BETWEEN ALL METAL SURFACES AND EDGES SEALED WITH MIN. 20 YEAR GUN-GRADE SEALANT.
5. USE #9 X 1" MIN. HWH WOOD GRIP SCREWS 3" O.C. MAX.

NOTE: It is recommended that all major panel rib ends and panel side or end laps be sealed with a gun-grade acrylic sealant and/or closures to deter insect and water penetration.

StayLOC Architectural Steel Roof System INSTALLATION INSTRUCTIONS

Installation Details

Vent and Chimney Installation Method

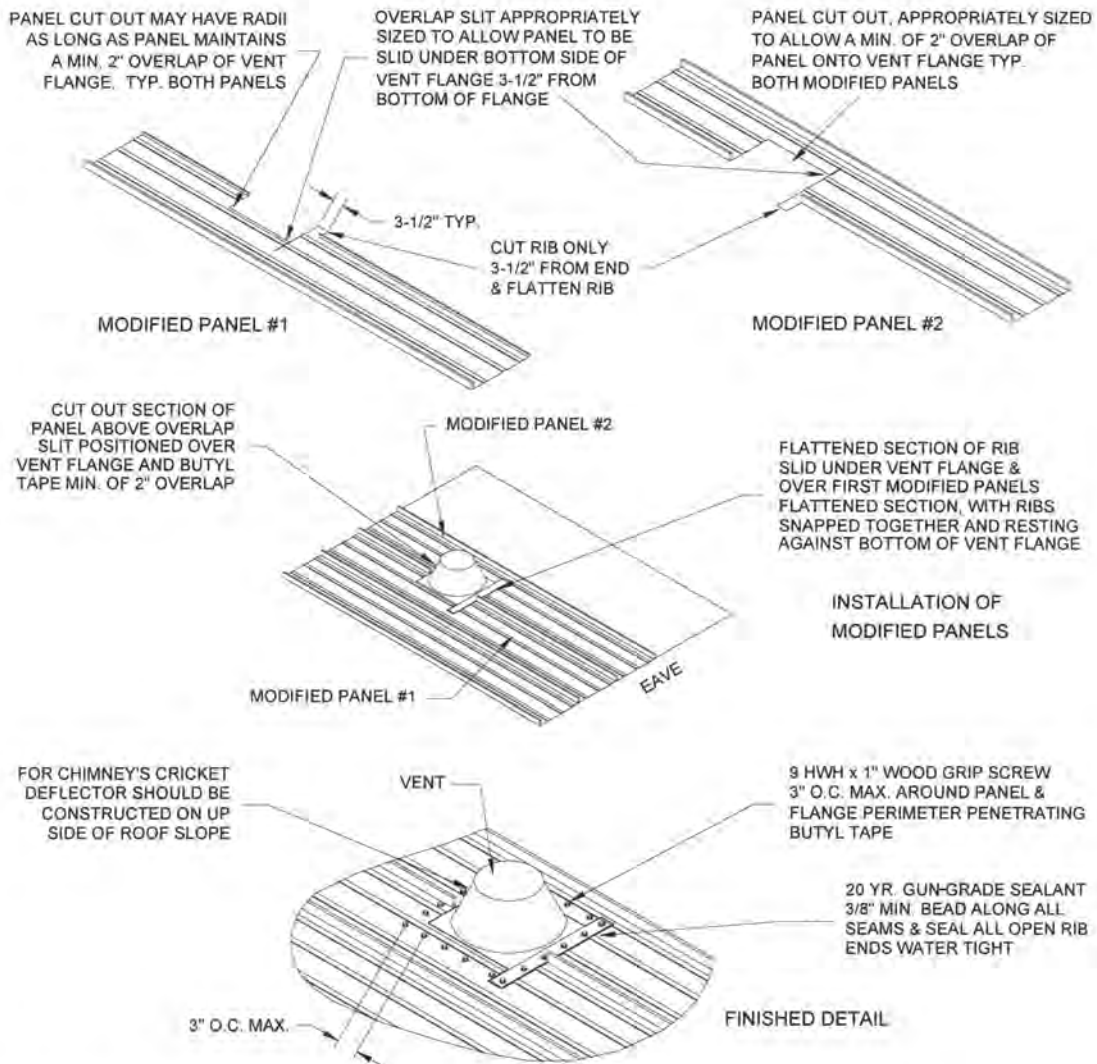

1. Vent fastened into place with one fastener in each upper corner.
2. Double butyl tape along bottom edge of under side of vent flange.
3. Double butyl tape on 3 sides (top, left, & right) top surface of vent flange.
4. NOTE: See fastening selection table for fastener type and spacing.
5. Install first modified panel. Slide panel over top of vent flange and under vent flange at overlap slit in panel.
6. Cut center panel(s) to match first modified panel at top of flange. Cut bottom center panel(s) and flatten 3" of panel, (at shown in Rib Detail). Slide flattened part of panel(s) under vent flange at bottom.
7. Install second modified panel. Slide panel over the top of vent flange and under vent flange at overlap slit in panel.
8. Fasteners around panel/vent overlap shall be 9 x 1" HWH wood grip min., 3" O.C. max.
9. 20 yr. min. gun-grade sealant to be used to seal along seams and rib ends.

NOTE: It is recommended that all major panel rib ends and panel side or end laps be sealed with a gun-grade acrylic sealant and/or closures to deter insect and water penetration.

StayLOC Architectural Steel Roof System INSTALLATION INSTRUCTIONS

Installation Details Overlapping StayLOC Panels

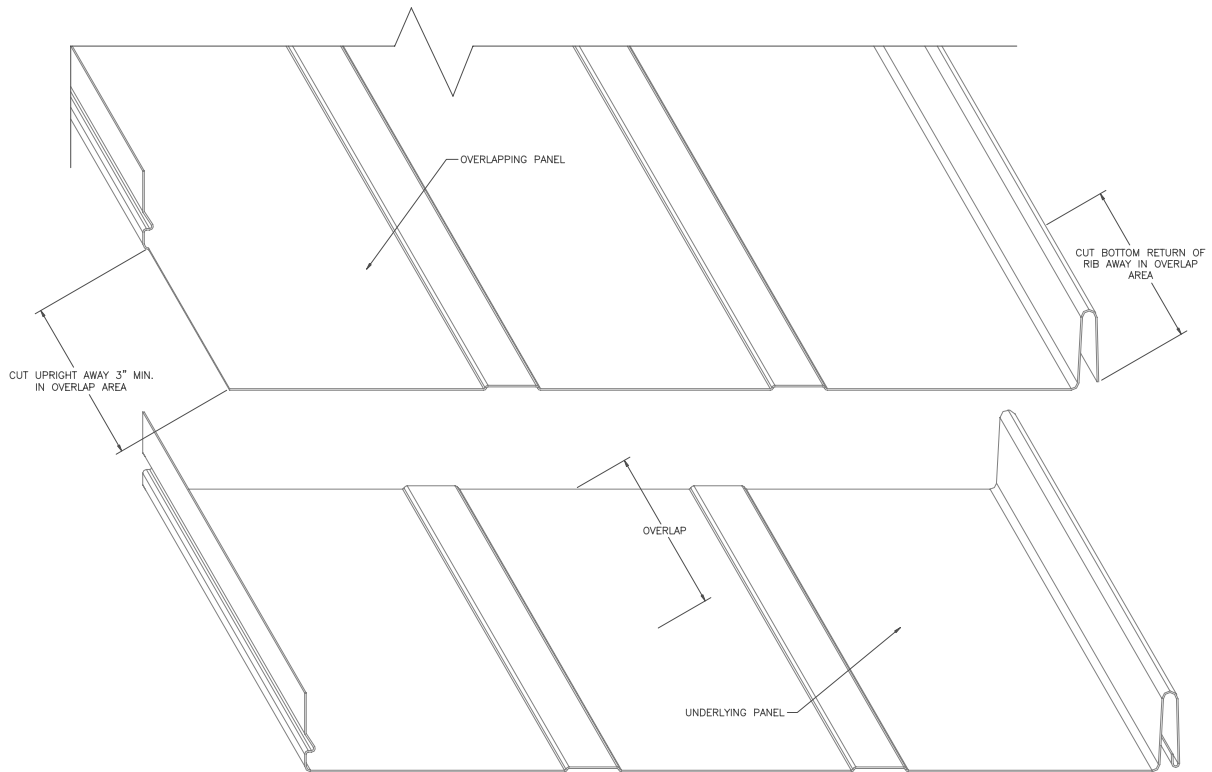

NOTE: It is recommended that all major panel rib ends and panel side or end laps be sealed with a gun-grade acrylic sealant and/or closures to deter insect and water penetration.

StayLOC Architectural Steel Roof System INSTALLATION INSTRUCTIONS

NOTES

Revised 4/16/08



ACM – Beloit (Headquarters)
1600 Park Ave.
Beloit, WI 3511
(608) 365-0296

ACM – Joplin, MO
2671 S. Kenser Rd.
Joplin, MO 64801
(417) 624-9140

ACM – Houston/
Stone Metal Products
11615 Brittmore Park Dr.
Houston, TX 77041
(713) 466-1797