

ROOFING *Accessories*



2017 Apollo Beach Plant
PRODUCT CATALOG

www.acm-metals.com

2017 Apollo Beach Plant
**ROOFING ACCESSORIES
CATALOG**

Table of Contents

Angle Flashing	2	Stucco Stop	8
Standard	2	Stucco Stop w/Caulk Bead	9
No Kick	2	Pre-Bent Step Flashing	9
Drip Edge	3-7	Rain Diverter	10
Professional (Closed Face)	3	Reglet Flashing	10
Standard (Closed Face)	3	Philly Flashing	10
Professional (Open Face)	3	Roll Valley	10
F-8 Large (Open Face)	4	W-Valley	11
26 Gauge Galvanized (Open Face)	4	Roof to Wall Flashing	11
Professional for Roof with 1/2" Overhang ...	4	Flat Sheet	11
Professional (Open Face)	5	Ventilation	12
Colorado Drip Edge	5	Gooseneck	12
Professional for Roof with 1/4" Overhang ...	6	Roof Jack	12
Roof Edge 90° with Kick	6	ACM Stone Coat Ventilation	12
Builders Alum. for Roof with 1/4" Overhang ..	6	Tile & Patio Accessories	13
Commercial for Roof with 1/4" Overhang	7	Tile Ridge Cap Riser	13
Premium for Roof with Overhang	7	Kick Plate Channel (Roll Form)	13
Rake Edge 90°	7	Finish Trim	13
Professional	7		
Gravel Stop	8		
Gutter Apron 25°	8		

All ACM products are painted with Valspar's Diamond Flex™ paint system.

valspar
if it matters, we're on it.®

We reserve the right to change the content of product offerings at any time. Please consult the online catalog at www.acm-metals.com for the most update product offering.

Contact Information:

CUSTOMER SERVICE: 800-749-4067



ACM ROOFING ACCESSORIES

Angle Flashing

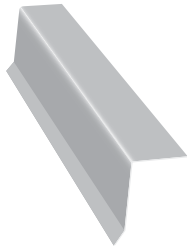

Part #	Description	Colors	Nom. Gauge/ Thickness	Piece Length	Pieces/ Box	Boxes/ Pallet	Pieces/ Pallet
Standard							
GAF25410ML	Galvanized 2.5 x 4 (C6)	Mill	26 ga	10'	10	35	350
GAF3310 - -	Galvanized 3 x 3 (C6)	BK, RB, WH	26 ga	10'	10	35	350
GAF3310ML	Galvanized 3 x 3 (C6)	Mill	26 ga	10'	10	35	350
GAF4410 - -	Galvanized 4 x 4 (C7)	BK, RB, WH	26 ga	10'	10	35	350
GAF4410ML	Galvanized 4 x 4 (C7)	Mill	26 ga	10'	10	35	350
GDE822 - -	Galv. 2 x 2, 90° Dual Safety Hem	RB, WH	28 ga	10'	10	68	680
GDE824 - -	Galv. 2 x 4, 90° Dual Safety Hem	BK, RB, WH	28 ga	10'	10	40	400
GDE8242 - -	Galv. 2 x 4, 120° Dual Safety Hem	BK, RB, WH	28 ga	10'	10	40	400

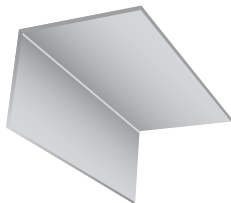
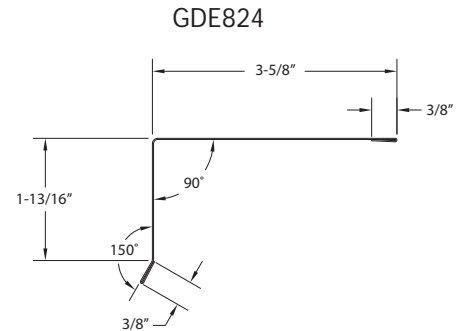
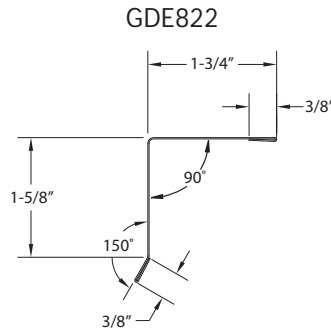
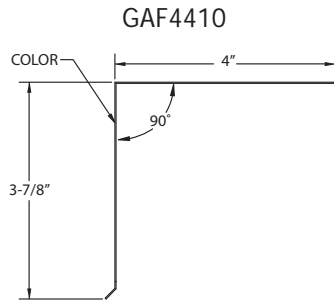
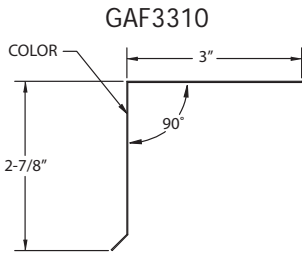

No Kick (Color Outside)

ABFA141TWH	Aluminum 1 x 4	WH	0.040	10'	25	20	500
ABFA231TWH	Aluminum 2 x 3	WH	0.040	10'	25	20	500
AAF2210WH	Aluminum 2 x 2	WH	0.025	10'	20	20	400
AAF4410ML	Aluminum 4 x 4	Mill	0.025	10'	20	20	400
AAF4510WH	Aluminum 4 x 5	WH	0.025	10'	20	20	400
AAF4510ML	Aluminum 4 x 5	Mill	0.025	10'	20	20	400
AAFH3232AL	Aluminum 3 x 2 with Hem	AL	0.032	10'	20	20	400
AAFH5510ML	Aluminum 5 x 5 with Hem	Mill	0.025	10'	20	20	400

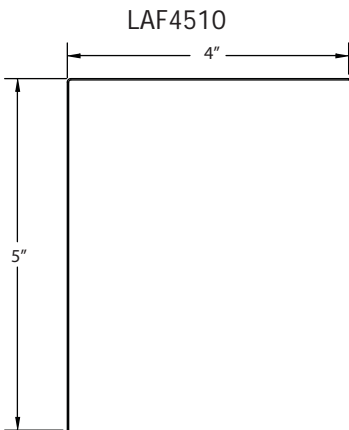

LJMD783ML	Galvalume J-Mold 7/8 x 3	Mill	26 ga/0.019	10'	25	20	500
LAF3210ML	Galvalume 3 x 2	Mill	26 ga/0.019	10'	20	20	400
LAF3310WH	Galvalume 3 x 3	WH	26 ga/0.019	10'	20	20	400
LAF3310ML	Galvalume 3 x 3	Mill	26 ga/0.019	10'	20	20	400
LAF4310ML	Galvalume 4 x 3	Mill	26 ga/0.019	10'	20	20	400
LAF4410ML	Galvalume 4 x 4	Mill	26 ga/0.019	10'	20	20	400
LAF4510WH	Galvalume 4 x 5	WH	26 ga/0.019	10'	20	20	400
LAF4510ML	Galvalume 4 x 5	Mill	26 ga/0.019	10'	20	20	400
LAF4610ML	Galvalume 4 x 6	Mill	26 ga/0.019	10'	20	20	400
LAF5510BK	Galvalume 5 x 5	BK	26 ga/0.019	10'	20	20	400
LAF5510ML	Galvalume 5 x 5	Mill	26 ga/0.019	10'	20	20	400
LAF5710ML	Galvalume 5 x 7	Mill	26 ga/0.019	10'	20	20	400

ALUMINUM Roofing Accessories Colors:

COLOR	CODE	COLOR	CODE
ALMOND	AL	WHITE	WH

STEEL Roofing Accessories Colors:

COLOR	CODE	COLOR	CODE	COLOR	CODE	COLOR	CODE
BLACK	BK	ROYAL BROWN	RB	TERRA BRONZE	TB	WHITE	WH

Drip Edge

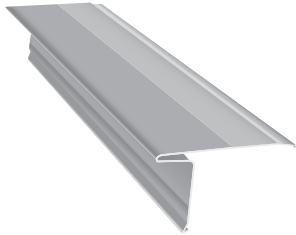

Part #	Description	Colors	Nom. Gauge/ Thickness	Piece Length	Pieces/ Box	Boxes/ Pallet	Pieces/ Pallet
Professional - Closed Face							
ADE10 - -	Aluminum 1" face with 2-7/8" back (F5)	BK, CA, DS, EG, MB PC, RB, TB, VG, WH	0.019	10'	50	24	1200
ADE15 - -	Aluminum 1-1/2" face with 3" back (F5)	AL, BK, PC, RB, WH, WI	0.019	10'	50	24	1200
ADE15ML	Aluminum 1-1/2" face with 3" back	Mill	0.019	10'	50	24	1200
ADE175BR	Aluminum 1-3/4" face with 2-1/2" back	BR	0.025	10'	25	20	500
ADE2415WH	Aluminum 1-1/2" face with 3" back (F5)	WH	0.024	10'	50	24	1200
ADE2420WH	Aluminum 2" face with 3" back (F5)	WH	0.024	10'	50	24	1200
ADE185 - -	Aluminum 1-3/4" face with 2-5/8" back	(Listed Below)	0.019	10'	50	24	1200
GDE15WH	Galvanized 1-1/2" face with 3" back	WH	30 ga	10'	25	24	600
GDE20 - -	Galvanized 2" face (ODE) with 3" back	RB, TB	28 ga	10'	25	24	600
LDE175BR	Galvalume 1-3/4" face with 2-1/2" back	BR	26 ga	10'	25	20	500
CDE15	Copper 1-1/2" face with 3" back		10 oz.	10'	10	48	480

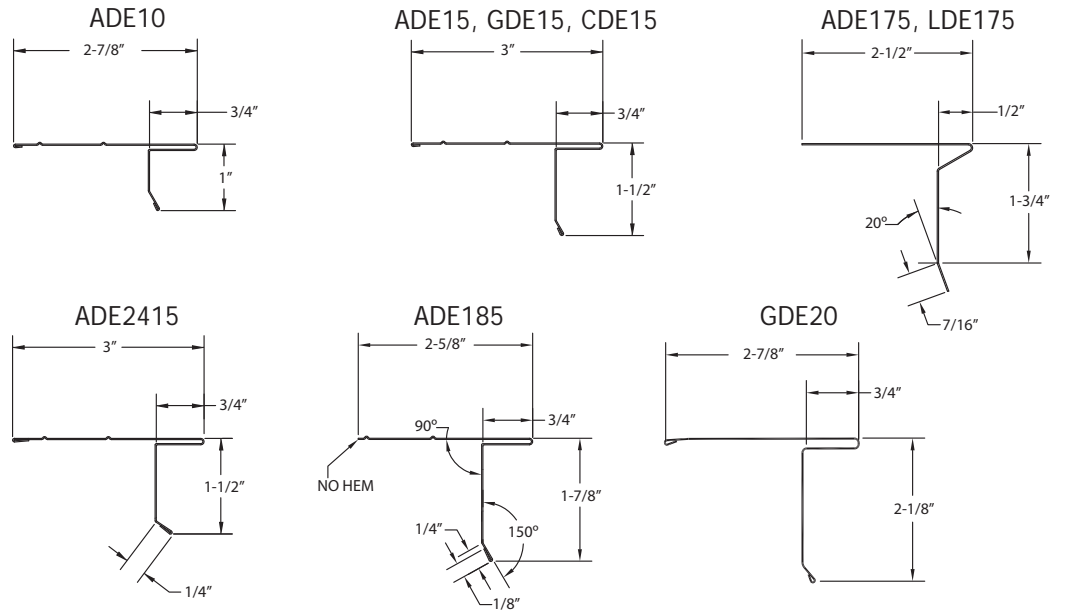

Standard - Closed Face

ESADE10 - -	Economy Aluminum 1" face (FSN4-1/2)	WH, RB	0.015	10'	50	24	1200
SADE125 - -	Aluminum 1-1/4" face	BK, WH	0.019	10'	50	24	1200
SADE15 - -	Aluminum 1-1/2" face (F5M)	BK, RB, TB, WH	0.019	10'	50	24	1200
SADE185 - -	Aluminum 1-3/4" face (F5M)	BZ, WH, WI	0.019	10'	50	24	1200
SGDE10ML	Galvanized 1" face (F4-1/2)	Mill	28 ga	10'	25	24	600
SGDE125 - -	Galvanized 1-1/4" face	BK, RB, WH	28 ga	10'	25	24	600
SGDE125ML	Galvanized 1-1/4" face	Mill	28 ga	10'	25	24	600
SGDE15ML	Galvanized 1-1/2" face (F5M)	Mill	28 ga	10'	25	24	600

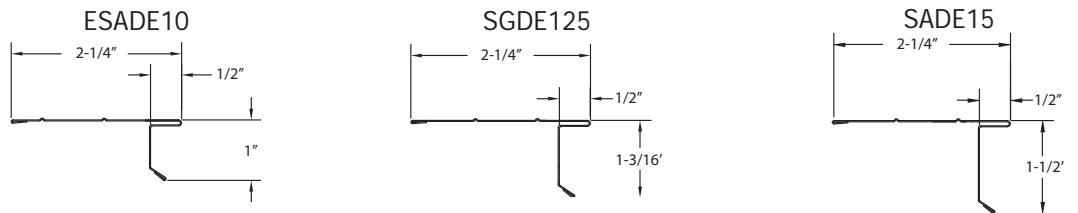

ALUMINUM Roofing Accessories Colors:

COLOR	CODE	COLOR	CODE	COLOR	CODE	COLOR	CODE	COLOR	CODE
ALMOND	AL	BROWN	BR	DESERT SAND	DS	PEBBLESTONE CLAY	PC	VICTORIAN GREY	VG
BLACK	BK	CAMEO	CA	EVERGREEN	EG	ROYAL BROWN	RB	WHITE	WH
BRONZE	BZ	CLAY	CL	MUSKET BROWN	MB	TERRA BRONZE	TB	WICKER	WI

STEEL Roofing Accessories Colors:

COLOR	CODE	COLOR	CODE	COLOR	CODE	COLOR	CODE
BLACK	BK	BROWN	BR	ROYAL BROWN	RB	TERRA BRONZE	TB
						WHITE	WH

Drip Edge *cont.*

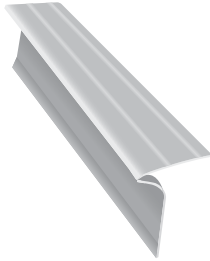

Part #	Description	Colors	Nom. Gauge/ Thickness	Piece Length	Pieces/ Box	Boxes/ Pallet	Pieces/ Pallet
Professional - Open Face							
ADEOF415	- Aluminum 1-1/2" open face w/2-1/2" back (F50)	BK, RB, WH	0.019	10'	50	24	1200
ADEOF415ML	- Aluminum 1-1/2" open face w/2-1/2" back (F50)	ML	0.019	10'	50	24	1200
ADEOF615	- Aluminum 2" open face w/3-1/2" back (F50)	WH, RB	0.019	10'	50	24	1200
ADEOF10	- Alum. 1-1/2" open face w/4" back (F5-1/20)	BK, RB, TB, WH	0.019	10'	50	24	1200
ADEOF10ML	- Alum. 1-1/2" open face w/4" back (F5-1/20)	Mill	0.019	10'	50	24	1200

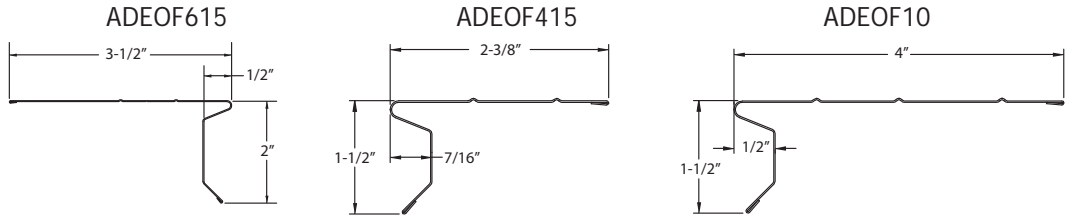

F-8 Large - Open Face

ADEF8	- Aluminum 1-1/2" open face w/5-3/4" back (F8)	BK, RB, WH	0.019	10'	25	24	600
-------	--	------------	-------	-----	----	----	-----

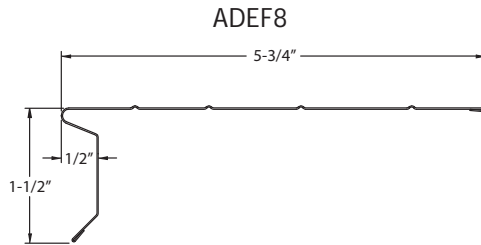

26 Gauge Galvanized - Open Face

GDEOF615	- Galvanized 2" open face with 3-1/2" back	RB, WH	26 ga	10'	20	24	480
----------	--	--------	-------	-----	----	----	-----

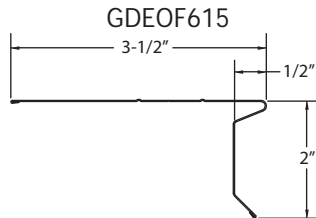

ALUMINUM Roofing Accessories Colors:

COLOR	CODE	COLOR	CODE	COLOR	CODE
BLACK	BK	ROYAL BROWN	RB	WHITE	WH

STEEL Roofing Accessories Colors:

COLOR	CODE	COLOR	CODE	COLOR	CODE	COLOR	CODE
BEIGE	BE	BLACK	BK	BROWN	BR	GREY	GY
WHITE	WH	WICKER	WI				

Drip Edge *cont.*

Part #	Description	Colors	Nom. Gauge/ Thickness	Piece Length	Pieces/ Box	Boxes/ Pallet	Pieces/ Pallet
Professional for Roof with 1/2" Overhang							
LDE25 - -	Galvalume 26 Ga 2-1/2" face	(Listed Below)	26 ga/0.019	10'	25	20	500
LDE20 - -	Galvalume 26 Ga 2" face	BK, BE, BR, WH	26 ga/0.019	10'	25	20	500
LDE15 - -	Galvalume 26 Ga 1-1/2" face	BK, BE, BR, WH	26 ga/0.019	10'	25	20	500
TDE25WH	TPO 24 Ga 2-1/2" face	WH	24 ga/0.024	10'	Order by the pc.		

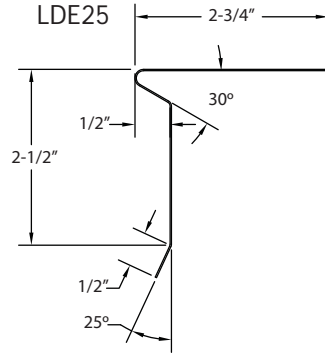

Professional - Open Face

ADE25 - -	Aluminum 2-1/2" face	BR, TWH	0.025	10'	25	20	500
ADE2545 - -	Aluminum 4-1/2" face	BR, TWH	0.025	10'	25	20	500
ADE256 - -	Aluminum 6" face	BR, TWH	0.025	10'	25	20	500
ADE2510 - -	Aluminum 10" face	BR, TWH	0.025	10'	25	20	500

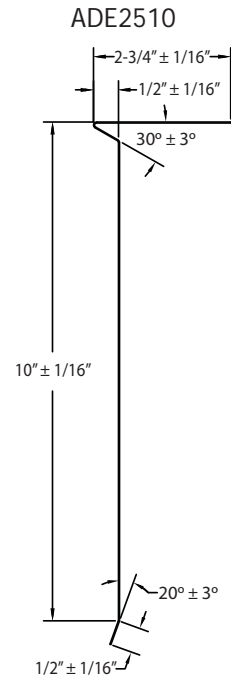
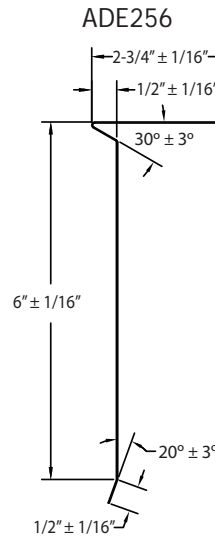
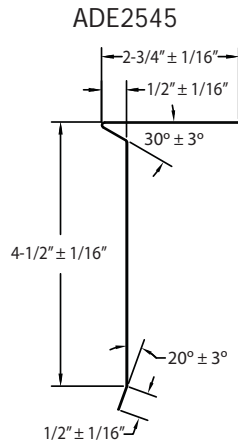

ALUMINUM Roofing Accessories Colors:

COLOR	CODE	COLOR	CODE
BROWN	BR	TAMPA WHITE	TWH

STEEL Roofing Accessories Colors:

COLOR	CODE	COLOR	CODE	COLOR	CODE	COLOR	CODE
BEIGE	BE	BLACK	BK	BROWN	BR	GREY	GY
WHITE	WH	WICKER	WI				

Drip Edge *cont.*

Part #	Description	Colors	Nom. Gauge/ Thickness	Piece Length	Pieces/ Box	Boxes/ Pallet	Pieces/ Pallet
Professional for Roof with 1/4" Overhang							
LDEEL22 - -	Glum. 26 Ga 2-3/4" face (Ext. Leg)	BK, BE, BR, GY, WH	26 ga/0.019	10'	25	20	500
LDEEL25 - -	Glum. 26 Ga 2-1/2" face (Ext. Leg)	BK, BE, BR, GY, WH	26 ga/0.019	10'	25	20	500

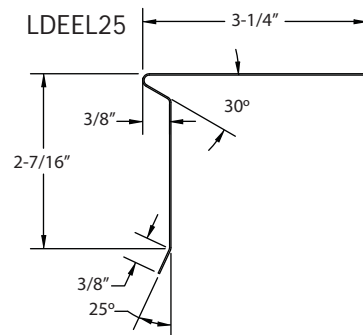
**Roof Edge - 90° with a Kick**

LRE22 - -	Galvalume 26 Ga 2 x 2	WH, BR	26 ga/0.019	10'	25	20	500
LRE22ML	Galvalume 26 Ga 2 x 2	Mill	26 ga/0.019	10'	25	20	500
LRE23WH	Galvalume 26 Ga 2 x 3	WH	26 ga/0.019	10'	25	20	500
LRE23ML	Galvalume 26 Ga 2 x 3	Mill	26 ga/0.019	10'	25	20	500
LRE33 - -	Galvalume 26 Ga 3 x 3	WH, BR, BK	26 ga/0.019	10'	25	20	500
LRE33ML	Galvalume 26 Ga 3 x 3	Mill	26 ga/0.019	10'	25	20	500
LRE2444 - -	Galvalume 24 Ga 4 x 4	WH, BR	24 ga/0.024	10'	25	20	500
LRE2444ML	Galvalume 24 Ga 4 x 4	Mill	24 ga/0.024	10'	25	20	500

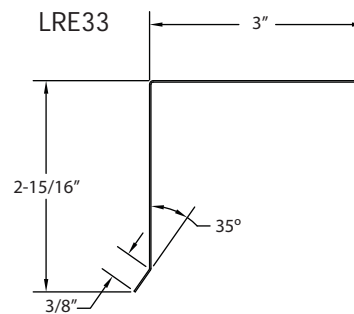
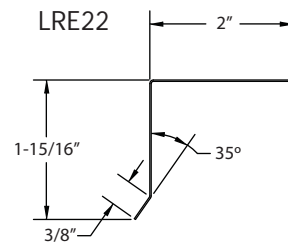

Part #	Description	Colors	Nom. Gauge/ Thickness	Piece Length	Pieces/ Box	Boxes/ Pallet	Pieces/ Pallet
Builders Aluminum for Roof with 1/4" Overhang							
ADEWB17TWH	Alum. 1-3/4" face wood grain w/hem	TWH	0.014	10'	50	24	1200
ADEB17TWH	Alum. 1-3/4" face w/hem	TWH	0.014	10'	50	24	1200

ALUMINUM Roofing Accessories Colors:

COLOR	CODE
TAMPA WHITE	TWH

STEEL Roofing Accessories Colors:

COLOR	CODE	COLOR	CODE	COLOR	CODE	COLOR	CODE	COLOR	CODE
BEIGE	BE	BLACK	BK	BROWN	BR	GREY	GY	WHITE	WH

Drip Edge *cont.*

Part #	Description	Colors	Nom. Gauge/ Thickness	Piece Length	Pieces/ Box	Boxes/ Pallet	Pieces/ Pallet
Commercial Aluminum for Roof with 1/4" Overhang							
ADEWC17T - -	Alum. 1-3/4" face wood grain w/hem	AI, AL, BN, CG, CO, HY, MB, WH	0.019	10'	50	24	1200
ADEC17T - -	Alum. 1-3/4" face w/hem	AI, AL, CG, CO HY, MB, WH, WI	0.019	10'	50	24	1200
ADEWC20TWH	Alum. 2" face wood grain w/hem	TWH	0.019	10'	50	24	1200
ADEC20TWH	Alum. 2" face w/hem	TWH	0.019	10'	50	24	1200
ADEWC25T - -	Alum. 2-1/2" face wood grain w/hem	AL, HY, MB, WH	0.019	10'	50	24	1200
ADEC25T - -	Alum. 2-1/2" face w/hem	HY, MB, WH	0.019	10'	50	24	1200

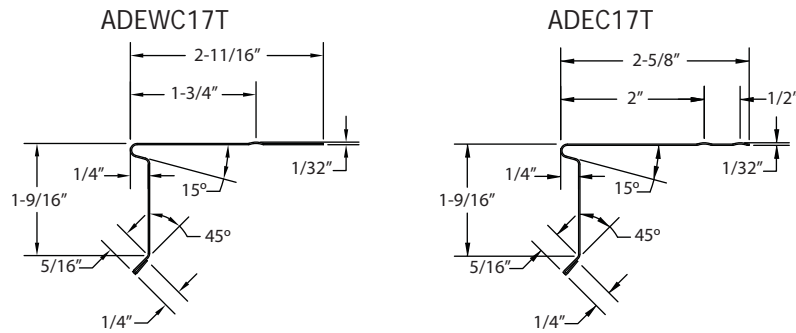

Premium Aluminum for Roof with 1/4" Overhang

ADEWD17T	Alum. 1-3/4" face wood grain w/hem	MB, WH	0.024	10'	50	24	1200
ADED17T - -	Alum. 1-3/4" face w/hem	BR, WH	0.024	10'	50	24	1200
ADEWD20T - -	Alum. 2" face wood grain w/hem	HY, MB, WH	0.024	10'	50	24	1200
ADED20TWH	Alum. 2" face w/hem	TWH	0.024	10'	50	24	1200
ADED25TWH	Alum. 2-1/2" face w/hem	SE, SM, WH	0.024	10'	50	24	1200

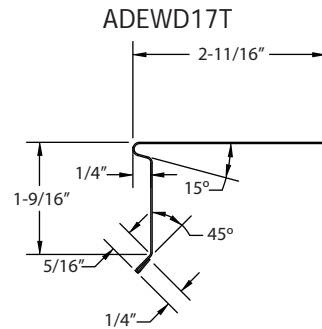

Rake Edge 90°

Part #	Description	Colors	Nom. Gauge/ Thickness	Piece Length	Pieces/ Box	Boxes/ Pallet	Pieces/ Pallet
Professional							
GRK15ML	Galvanized 1-1/2" face with 2-11/16" back	Mill	28 ga	10'	25	27	675

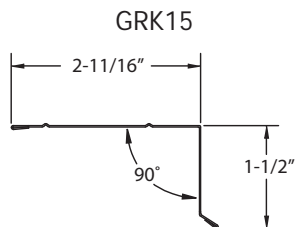

ALUMINUM Roofing Accessories Colors:

COLOR	CODE	COLOR	CODE	COLOR	CODE	COLOR	CODE	COLOR	CODE
ALMOND	AL	BROWN	BR	HICKORY BROWN	HY	SOFT MAPLE	SM	WHITE	WH
ANTIQUÉ IVORY	AI	CHARCOAL GREY	CG	MUSKET BROWN	MB	TAMPA WHITE	TWH	WICKER	WI
BONE	BN	COLONIAL GREY	CO	STERLING	SE				

Gravel Stop



Part #	Description	Color	Nom. Gauge/ Thickness	Piece Length	Pieces/ Box	Pieces/ Bundle	Boxes/ Pallet	Pieces/ Pallet
AGS30WH	Aluminum 3" face Closed	WH	26 ga/0.019	10'		25		
LGSO30 - -	Galvalume 3" face Open	WH, BR	26 ga/0.019	10'		25		
LGSO30ML	Galvalume 3" face Open	Mill	26 ga/0.019	10'		25		
LGSC30 - -	Galvalume 3" face Closed	WH, BR	26 ga/0.019	10'		25		
LGSC30ML	Galvalume 3" face Closed	Mill	26 ga/0.019	10'		25		
LGSC40ML	Galvalume 4" face Closed	Mill	26 ga/0.019	10'		25		
LGSCC88ML	Galvalume 8" face Closed	Mill	26 ga/0.019	10'		25		
GG30ML	Galvanized 3" face (H6F)	Mill	26 ga	10'	10		35	350
GG340ML	Galvanized 4" face (H6F)	Mill	26 ga	10'	10		35	350

AGS30, GGS30

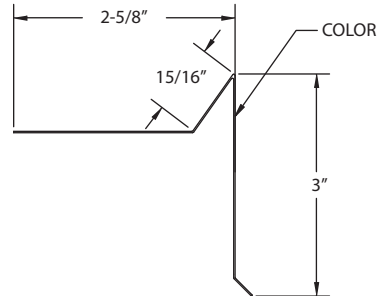

Gutter Apron 25°



Part #	Description	Color	Nom. Gauge/ Thickness	Piece Length	Pieces/ Box	Pieces/ Bundle	Boxes/ Pallet	Pieces/ Pallet
AGA15WH	Aluminum 1-1/2" face	WH	0.019	10'	50		32	1600
AGA20 - -	Aluminum 2" face	BK, RB, WH	0.019	10'	50		32	1600
LGA20110 - -	Galvalume 2" face 110°	BK, BR, WH	26 ga/0.019	10'		25	20	500
LGA20110ML	Galvalume 2" face 110°	Mill	26 ga/0.019	10'		25	20	500
LGA23110 - -	Glum. 2" face 110° w/3" Leg on Roof	BK, BR, WH	26 ga/0.019	10'		25	20	500
LGA23110ML	Glum. 2" face 110° w/3" Leg on Roof	Mill	26 ga/0.019	10'		25	20	500
LGA30110 - -	Galvalume 3" face 110°	BK, BR, WH	26 ga/0.019	10'		25	20	500
LGA30110ML	Galvalume 3" face 110°	Mill	26 ga/0.019	10'		25	20	500
GGA15WH	Galvanized 1-1/2" face	WH	28 ga	10'		25	32	800

AGA15, GGA15

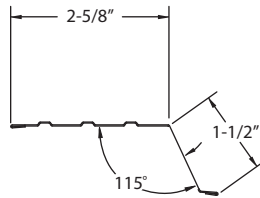

AGA20

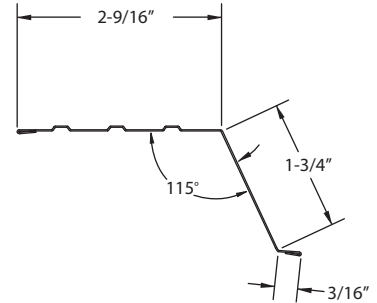

Stucco Stop



Part #	Description	Colors	Nom. Gauge/ Thickness	Piece Length	Pieces/ Bundle	Boxes/ Pallet	Pieces/ Pallet
LOF5ML	Galvalume 5"	Mill	26 ga/0.019	10'	25	20	500
LOF55ML	Galvalume 5-1/2"	Mill	26 ga/0.019	10'	25	20	500
LOF6ML	Galvalume 6"	Mill	26 ga/0.019	10'	25	20	500

ALUMINUM Roofing Accessories Colors:

COLOR	CODE	COLOR	CODE	COLOR	CODE
BLACK	BK	ROYAL BROWN	RB	WHITE	WH

STEEL Roofing Accessories Colors:

COLOR	CODE	COLOR	CODE	COLOR	CODE
BLACK	BK	BROWN	BR	WHITE	WH

Stucco Stop with Caulk Bead

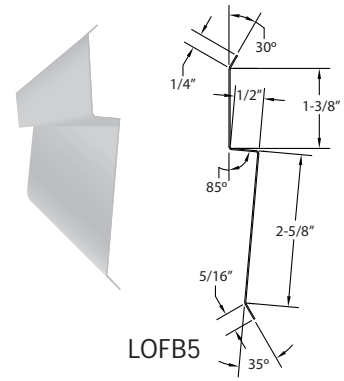

Part #	Description	Colors	Nom. Gauge/ Thickness	Piece Length	Pieces/ Bundle	Boxes/ Pallet	Pieces/ Pallet
AOFB5ML	Aluminum 5"	Mill	0.032	10'	25	20	500
LOFB5ML	Galvalume 5"	Mill	26 ga/0.019	10'	25	20	500
LOFB55ML	Galvalume 5-1/2"	Mill	26 ga/0.019	10'	25	20	500
LOFB6ML	Galvalume 6"	Mill	26 ga/0.019	10'	25	20	500

Pre-Bent Step Flashing

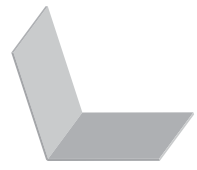

Part #	Description	Color	Nom. Gauge/ Thickness	Piece Length	Pieces/ Bundle	Pieces/ Box
APSF1788TB	Aluminum .017 x 8 x 8	TB	0.017	8"	100	500
APSF57 - -	Aluminum 2-1/2 x 2-1/2 x 7	BK, RB	0.011	7"	100	500
APSF57ML	Aluminum 2-1/2 x 2-1/2 x 7	Mill	0.011	7"	100	500
APSF237 - -	Aluminum 2 x 3 x 7	BK, RB	0.011	7"	100	500
APSF237ML	Aluminum 2 x 3 x 7	Mill	0.011	7"	100	500
APSF2885BK	Aluminum .024 x 8 x 8	BK	0.024	8"	50	500
APSF347 - -	Aluminum 3 x 4 x 7	BK, RB, TB	0.011	7"	100	500
APSF347ML	Aluminum 3 x 4 x 7	Mill	0.011	7"	100	500
APSF88 - -	Aluminum 8 x 8	BK, RB, TB	0.011	8"	100	500
APSF88ML	Aluminum 8 x 8	Mill	0.011	8"	100	500
APSF557BK	Aluminum 5 x 5 x 7	BK	0.011	7"	100	500
APSF558BK	Aluminum 5 x 5 x 8	BK	0.011	8"	100	500
LPSF57ML	Galvalume 2-1/2 x 2-1/2 x 7	Mill	0.011	7"	100	500
GPSF347ML	Galvanized 3 x 4 x 7	Mill	30 ga	7"	100	500
GPSF88ML	Galvanized 8 x 8	Mill	30 ga	8"	100	500
CPSF914	Copper 9 x 14	Mill	10 oz	14"	25	

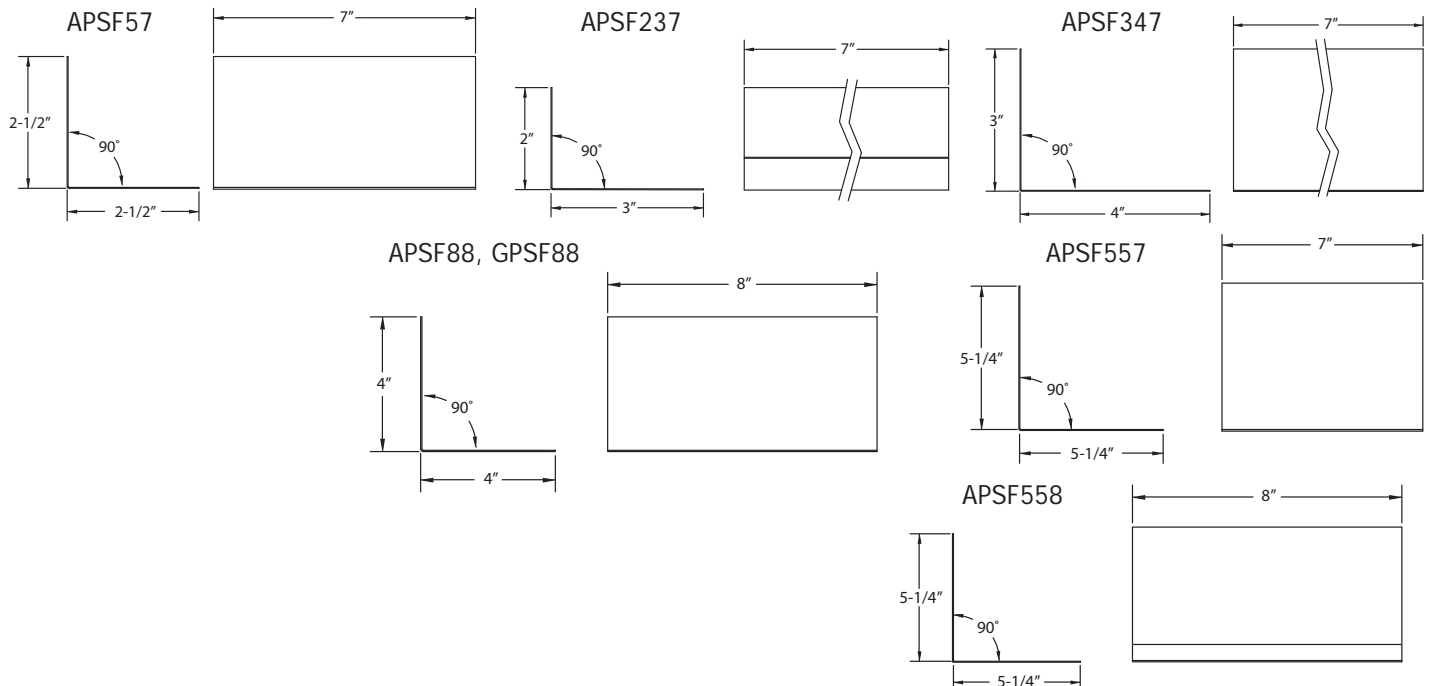

ALUMINUM Roofing Accessories Colors:

COLOR	CODE	COLOR	CODE	COLOR	CODE
BLACK	BK	ROYAL BROWN	RB	WHITE	WH

Rain Diverter

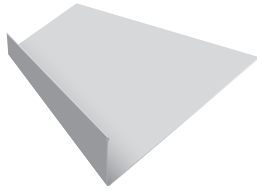

Part #	Description	Colors	Nom. Gauge/ Thickness	Piece Length	Pieces/ Bundle	Bundles/ Pallet	Pieces/ Pallet
GRD824 - -	Galvanized 2 x 4	BK, RB, TB	28 ga	10'	25	20	500
GRD710 - -	Galvanized 7"	BK, RB	26 ga	10'	10	25	250
GRD710ML	Galvanized 7"	Mill	26 ga	10'	10	25	250

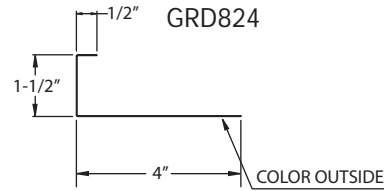
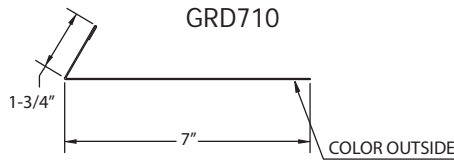

Reglet Flashing

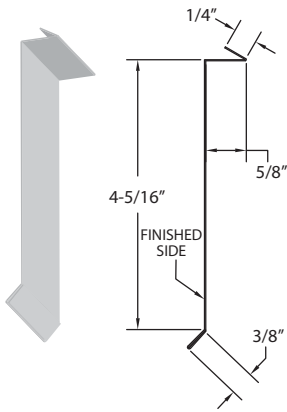

Part #	Description	Colors	Nom. Gauge/ Thickness	Piece Length	Pieces/ Box	Boxes/ Pallet	Pieces/ Pallet
GRF410 - -	Galvanized 4"	BK, RB, TB	26 ga	10'	10	25	250
GRF410ML	Galvanized 4"	Mill	26 ga	10'	10	25	250

Philly Flashing



Part #	Description	Colors	Nom. Gauge/ Thickness	Piece Length	Pieces/ Bundle	Boxes/ Pallet	Pieces Pallet
LPHF310ML	Galvalume 3"	Mill	26 ga/0.019	10'	20	20	400
LPHF410ML	Galvalume 4"	Mill	26 ga/0.019	10'	20	20	400

Roll Valley



Part #	Description	Colors	Nom. Gauge/ Thickness	Piece Length	Pieces/ Box	Boxes/ Pallet	Pieces/ Pallet
ARV10ML	Aluminum 10"	Mill	0.011	50'	1	25	25
ARV12ML	Aluminum 12"	Mill	0.011	50'	1	25	25
ARV14ML	Aluminum 14"	Mill	0.011	50'	1	25	25
ARV20ML	Aluminum 20"	Mill	0.011	50'	1	25	25
LRV26165GL	Galvalume 16"	Mill	26 ga/0.019	50'	1	50	50
GRV10ML	Galvanized 10"	Mill	30 ga	50'	1	25	25
GRV12ML	Galvanized 12"	Mill	30 ga	50'	1	25	25
GRV14ML	Galvanized 14"	Mill	30 ga	50'	1	25	25
GRV17165ML	Galvanized 16"	Mill	26 ga/0.019	50'	1	50	50
GRV20ML	Galvanized 20"	Mill	30 ga	50'	1	25	25
GRV24ML	Galvanized 24"	Mill	30 ga	50'	1	25	25
GRV26205ML	Galvanized 20"	Mill	26 ga/0.019	50'	1	50	50
CRV116	Copper 16"	80 lb	10 oz	60'	1		
CRV124	Copper 24"	100 lb	10 oz	50'	1		

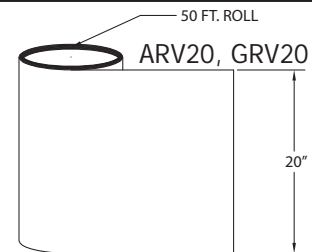
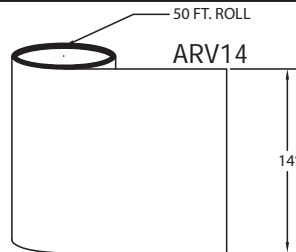
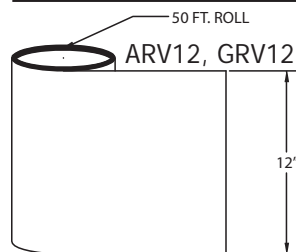

W-Valley



Part #	Description	Colors	Nom. Gauge/ Thickness	Piece Length	Pieces/ Box	Pieces/ Pallet
AWV24 - -	Aluminum 24" W-Valley	BK, BZ, RB, TB	0.019	10'		100
LSV18ML	Galvalume 18" W-Valley Shingle	Mill	26 ga/0.019	10'	25	50
LSVH18ML	Galvalume 18" W-Valley Shingle w/Hem	Mill	26 ga/0.019	10'	25	50
GWV18BK	Galvanized 18" W-Valley	BK	30 ga	10'		100
GWV2620BK	Galvanized 20" W-Valley	BK	30 ga	10'		100
GWBV2620 - -	Galvanized 20" Water Brake Valley	BK, RB, WW	26 ga	10'	50	

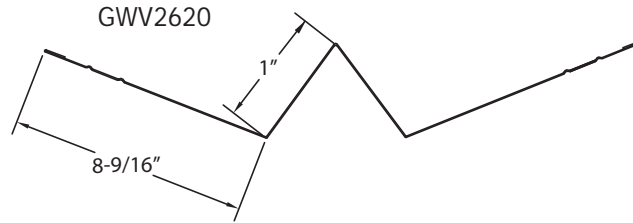

Roof to Wall Flashing

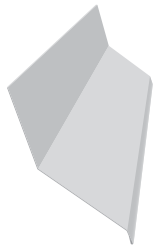

Part #	Description	Colors	Nom. Gauge/ Thickness	Piece Length	Pieces/ Box	Boxes/ Pallet	Pieces/ Pallet
ARTW4410TB	Aluminum 4 x 4	TB	0.019	10'	25	25	625
GRTW3310 - -	Galvanized 3 x 3	BK, RB, WH	26 ga	10'	10	10	250
GRTW4410ML	Galvanized 4 x 4	Mill	26 ga	10'	10	10	250
SCARW4410 - -	ACM Stone Coat 4 x 4	(SC Colors Below)		10'	10	24	240

ACM Stone Coat is available in these roof granule blends: B3 - Bark Brown, BH - Beach Brown, BK - Black, C4 - Cedarwood, C3 - Charcoal, S6 - Sierra Brown, WW - Weatherwood, GN - Green, MU - Musket Pebble, PE - Pearl White.



ACM Stone Coat 4x4
Roof to Wall Flashing

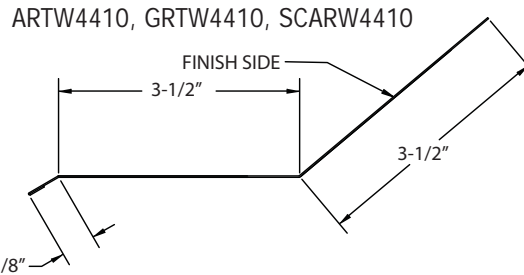

Flat Sheet

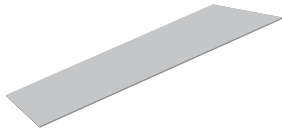

Part #	Description	Colors	Nom. Gauge/ Thickness	Piece Length	Pieces/ Pallet
LFS648GL	Galvalume 4' x 10'	Mill	26 ga/0.019	10'	100
LFS448GL	Galvalume 4' x 10'	Mill	24 ga/0.024	10'	100

ALUMINUM Roofing Accessories Colors:

COLOR	CODE	COLOR	CODE	COLOR	CODE	COLOR	CODE	COLOR	CODE
BLACK	BK	BRONZE	BZ	ROYAL BROWN	RB	TERRA BRONZE	TB	WEATHERED WOOD	WW

STEEL Roofing Accessories Colors:

COLOR	CODE	COLOR	CODE	COLOR	CODE
BLACK	BK	ROYAL BROWN	RB	WHITE	WH

Goose Neck

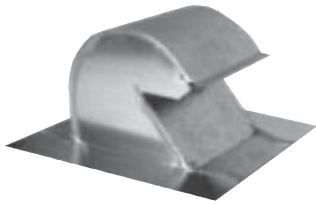

Part #	Description	Colors	Nom. Gauge/ Thickness	Piece Length	Pieces/ Box	Boxes/ Pallet
★LGND4 - -	Galvalume 4" Damp	WH, BK	26 ga/0.019	6-1/8	24	12
★LGND4ML	Galvalume Tile 4" Damp	Mill	26 ga/0.019	13.5	10	12
★LGND6ML	Galvalume 6" Damp	Mill	26 ga/0.019	6-1/8	16	12
★LGND6ML	Galvalume Tile 6" Damp	Mill	26 ga/0.019	13	6	12
★LGND10ML	Galvalume 10" Damp	Mill	26 ga/0.019	8-7/8	6	12
★LGND10 - -	Galvalume 10" Damp	BR	26 ga/0.019	8-7/8	6	12
★LGND10ML	Galvalume Tile 10" Damp	Mill	26 ga/0.019	14-1/8	4	12

★ "U" Status: Use up until gone.

Roof Jacks

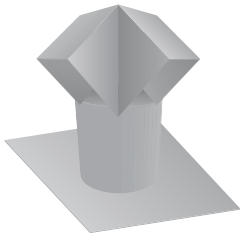

Part #	Description	Colors	Nom. Gauge/ Thickness	Pieces/ Box	Boxes/ Pallet
GRJ50ML	Galvanized 5" 0/12P	Mill	26 ga/0.019	8	12
GRJ54ML	Galvanized 5" 4/12P	Mill	26 ga/0.019	8	12
GRJ100ML	Galvanized 10" 0/12P	Mill	26 ga/0.019	5	12
GRJ104ML	Galvanized 10" 4/12P	Mill	26 ga/0.019	5	12

Stone Coat Ventilation

Part #	Description	Colors	Pieces/ Box	Boxes/ Pallet
--------	-------------	--------	----------------	------------------

Roof Vents

SCARVA51 - -	Mushroom Roof Vent	*(listed below)	8	9
<i>Mushroom vent is used for pitches 8/12 or less and provides 50 square inches of net free air flow per vent.</i>				
SCASLA - -	Slant Back Roof Vent	*(listed below)	6	9
<i>Slant backs can be used on most roof pitches and provides 50 square inches of net free air flow per vent. The slanted portion keeps water from coming in the back of the vent and has a guard to keep out bird nests.</i>				
SCALCPF - -	Power Vent	*(listed below)	1	30
<i>Power vent includes a thermo-humidistat. This vent is a great way to eliminate the thermo clime between upper and lower sections of the home. The power fan empties out the hot air in the attic which ultimately saves on the cooling costs.</i>				

Low Profile Ridge Vent & Accessories

SCALRV10 - -	Low Profile Ridge Vent	*(listed below)	8	12
<i>The 10' sections install quickly over convention ridge vents. Straps are not necessary because of the interlocking male-female ends of the panel. The ridge vent features 18" net free air flow per foot. Ridge vent also includes a patented baffle to prevent rain and snow from infiltrating the vent.</i>				
SCLPVEC - -	Low Profile Ridge Vent End Caps		24	192

Pipe Jack

SCAPF13 - -	1.5" - 3" Pipe Jack	*(listed below)	12	60
SCAPF34 - -	3" - 4" Pipe Jack	*(listed below)	12	60

Pipe flashings have rubber boots that can be trimmed to fit various sizes of roof pipe stacks.

*ACM Stone Coat is available in these roof granule blends: B3 - Bark Brown, BH - Beach Brown, BK - Black, C4 - Cedarwood, C3 - Charcoal, S6 - Sierra Brown, WW - Weatherwood, GN - Green, MU - Musket Pebble, PE - Pearl White.

Mushroom or Slant Back Roof Vents

TL Attic Sq. Footage	Number of Vents	Net Free Area Square Inches
0-1000	5	250
1001-1500	7	350
1501-2000	10	500
2001-2500	12	600
2501-3000	15	750

Low Profile Ridge Vent

TL Attic Sq. Footage	Footage of Ridge Vents	Net Free Area Square Inches
0-1000	14'	250
1001-1500	20'	350
1501-2000	27'	500
2001-2500	33'	600
2501-3000	44'	800

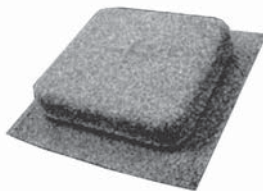

Mushroom Roof Vent

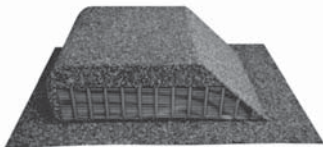

Slant Back Roof Vent

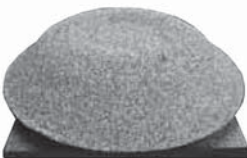

Power Vent



Low Profile Ridge Vent

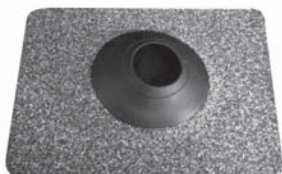

Pipe Jack

Tile Ridge Cap Riser

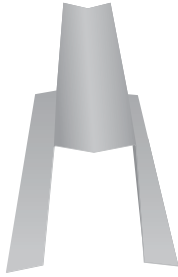

Part #	Description	Colors	Nom. Gauge/ Thickness	Piece Length	Pieces/ Bundle	Pieces/ Pallet
LRCR3ML	Galvalume 3"	Mill	26 ga/0.019	10'	15	75
LRCR4ML	Galvalume 4"	Mill	26 ga/0.019	10'	15	75
LRCR5ML	Galvalume 5"	Mill	26 ga/0.019	10'	15	75
LRCR6ML	Galvalume 6"	Mill	26 ga/0.019	10'	15	75

**Kick Plate Channel
(Roll Form)**

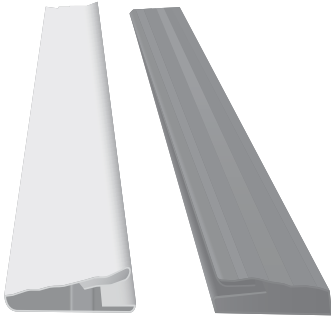

Part #	Description	Colors	Nom. Gauge/ Thickness	Piece Length	Pieces/ Bundle
AKP10T - -	Aluminum 10'	80, BZ	0.024	10'	25
AKP12T - -	Aluminum 12'	BZ, WH, 80	0.024	12'	25

Finish Trim

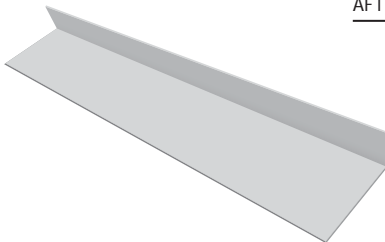

Part #	Description	Colors	Nom. Gauge/ Thickness	Piece Length	Pieces/ Bundle
AFTTWH	Aluminum 1" x 2" x 11-7/8"	WH	0.030	11-7/8"	25

Patio Accessories Colors:

COLOR	CODE	COLOR	CODE	COLOR	CODE
BRONZE	BZ	WHITE	WH	80 WHITE	80

ROOFING *Accessories*



**ACM is a “one stop shop”
manufacturing system for all
your exterior metal products.**

ACM manufactures rainware, edge metals, trim coil, soffit and fascia, siding accessories, and metal roofing in aluminum, steel, and copper. We are constantly upgrading our plants and machinery to improve quality, add additional profiles, and create new innovative products.

**Aluminum is made with majority of
post consumer waste.**

Aluminum and steel are recyclable, aluminum even more so. Did you know that Aluminum can be recycled over and over again? 75% of all aluminum ever smelted is still being recycled.

We keep Green Circle Certificates on hand for your access proving that 75% more of our raw material comes from recycled consumer waste. You may use this information to advertise that you are a “Green” company or as back-up documentation for government projects.

For Customer Service: 800-749-4067



ROOFING *Accessories*

Apollo Beach Plant Coverage Region

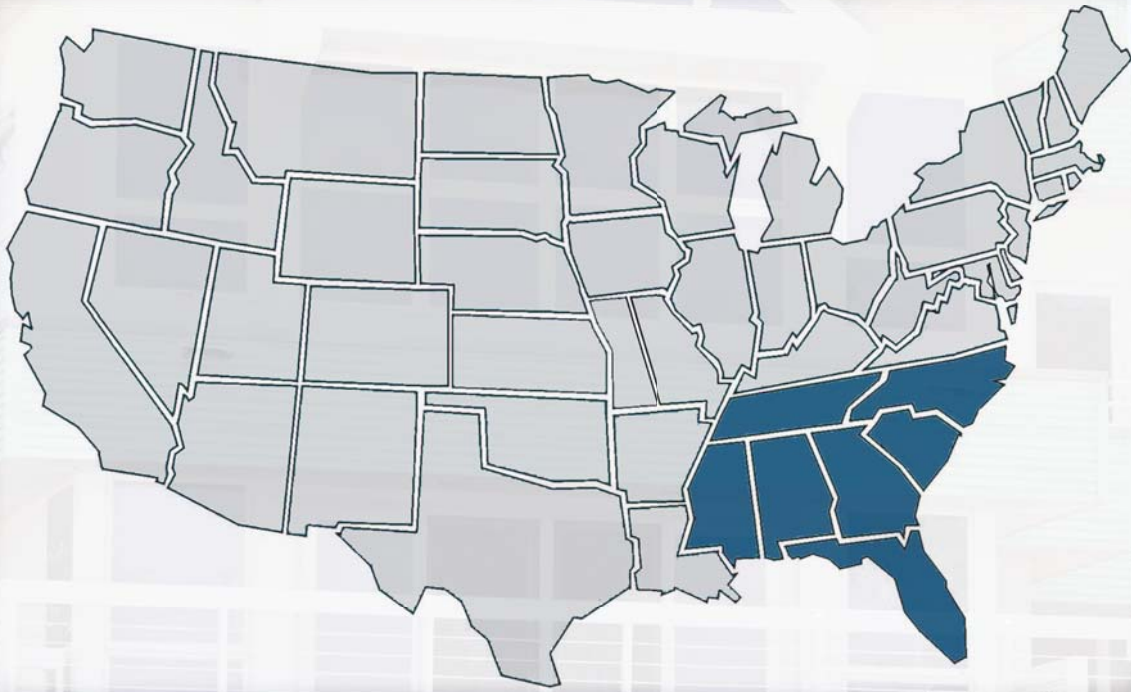

Customer Service: 800-749-4067
www.acm-metals.com